

# DEPARTMENT OF ACCOUNTING AND GENERAL SERVICES

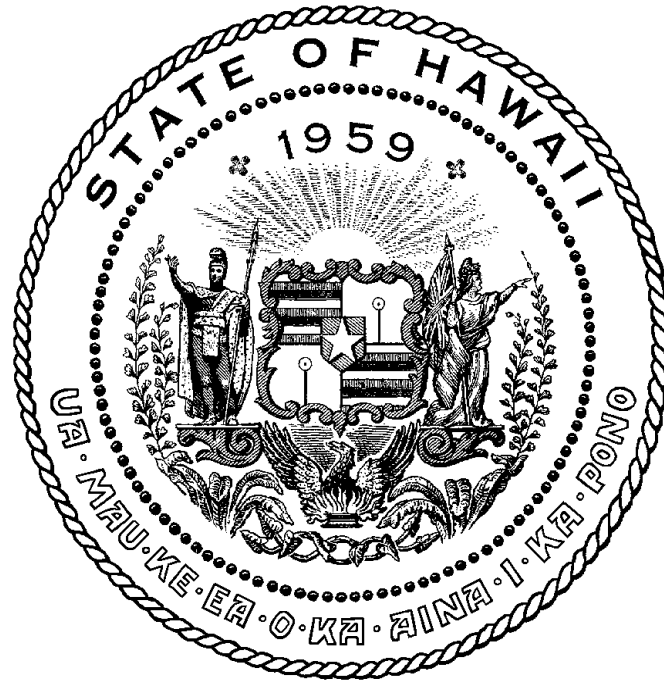

FY 2020-2021

ORGANIZATION AND POSITION ORGANIZATION CHARTS  
FUNCTIONAL STATEMENTS

# ORGANIZATION AND POSITION ORGANIZATION CHARTS

**TABLE OF CONTENTS-ORGANIZATION AND POSITION ORGANIZATION CHARTS**

	<u>Page</u>
Department (Organization Chart I).....	1
Department Administration (Organization Chart II).....	2
Office of the Comptroller (Position Organization Chart II-A).....	3
Personnel Office (Position Organization Chart II-B).....	4
Systems and Procedures Office (Position Organization Chart II-C).....	5
Administrative Services Office (Position Organization Chart II-D).....	6
Accounting Services (Position Organization Chart II-E).....	7
Audit Division (Organization Chart III).....	8
Audit Division (Position Organization Chart III-A).....	9
Internal Audit Services Branch (Position Organization Chart III-B).....	10
Project Audit Services Branch (Position Organization Chart III-C).....	11
Accounting Division (Organization Chart IV).....	12
Accounting Division (Position Organization Chart IV-A).....	13
Uniform Accounting and Reporting Branch (Position Organization Chart IV-B).....	14
Systems Accounting Branch (Position Organization Chart IV-C).....	15
Pre-Audit Branch (Position Organization Chart IV-D).....	16
Technical Support Office (Position Organization Chart IV-E).....	17
 <b><u>OFFICE OF ENTERPRISE TECHNOLOGY SERVICES</u></b>	
Office of Enterprise Technology Services and Information Technology Steering Committee (Organization Chart XVVV).....	18
Office of Enterprise Technology Services (Organization Chart V).....	19
Office of Enterprise Technology Services (Position Organization Chart V-A).....	20
Administrative Services Office (Position Organization Chart V-B).....	21
IT Operations Office, Production Services Branch (Position Organization Chart V-C).....	22
Production Management Section, Computer Operations Unit (Position Organization Chart V-D).....	23
Production Management Section, Scheduling and Control Unit (Position Organization Chart V-E).....	24
Network Control and Equipment Support Section, Network Control Unit (Position Organization Chart V-F).....	25
IT Operations Office, Systems Services Branch (Position Organization Chart V-G).....	26
IT Operations Office, Technology Support Services Branch (Position Organization Chart V-H).....	27
IT Operations Office, Client Services Branch (Position Organization Chart V-I).....	28
IT Operations Office, Enterprise Systems Branch (Position Organization Chart V-J).....	29
IT Operations Office, Network Branch (Position Organization Chart V-K).....	30
Security Office, Security Branch (Position Organization Chart V-L).....	31
IT Governance Office, Program Management Branch (Position Organization Chart V-M).....	32
IT Governance Office, Program Management Branch, Payroll Section (Position Organization Chart V-N).....	33
IT Governance Office, Enterprise Architect Branch (Position Organization Chart V-O).....	34

	<u>Page</u>
Central Services Division (Organization Chart VI) .....	35
Central Services Division (Position Organization Chart VI-A).....	36
Program Services Office and Purchasing Services Office (Position Organization Chart VI-A) .....	36
Public Building Repair and Alterations Branch (Organization Chart VI.1).....	37
Public Building Repair and Alterations Branch (Position Organization Chart VI-B).....	38
Public Building Management Services Branch (Organization Chart VI.2).....	39
Public Building Management Services Branch (Position Organization Chart VI-C) .....	40
Building Management Unit A (Position Organization Chart VI-D) .....	41
Building Management Unit B (Position Organization Chart VI-E) .....	42
Building Management Unit C (Position Organization Chart VI-F) .....	43
Building Management Unit D (Position Organization Chart VI-G) .....	44
Grounds Maintenance Section (Position Organization Chart VI-H).....	45
Public Works Division (Organization Chart VII) .....	46
Public Works Division (Position Organization Chart VII-A).....	47
Staff Services Office (Position Organization Chart VII-B).....	48
Technical Services Office (Position Organization Chart VII-C).....	49
Planning Branch (Position Organization Chart VII-D) .....	50
Project Management Branch (Position Organization Chart VII-E).....	51
Construction Management Branch (Position Organization Chart VII-F).....	52
Leasing Services Branch (Position Organization Chart VII-G).....	53
Archives Division (Organization Chart VIII).....	54
Archives Division (Position Organization Chart VIII-A).....	55
Automotive Management Division (Organization Chart IX).....	56
Automotive Management Division (Position Organization Chart IX-A).....	57
Land Survey Division (Organization Chart X).....	58
Land Survey Division (Position Organization Chart X-A).....	59
Hawaii District Office (Organization Chart XI).....	60
Hawaii District Office (Position Organization Chart XI-A).....	61
Central Services Branch 1, Hilo-Kau Section (Position Organization Chart XI-B).....	62
Central Services Branch 2, Honokaa-Kohala, Roving Crew, and Kona Sections (Position Organization Chart XI-C).....	63
Maui District Office (Organization Chart XII).....	64
Maui District Office (Position Organization Chart XII-A).....	65
Central Services Branch (Position Organization Chart XII-B) .....	66

	<u>Page</u>
Kauai District Office (Organization Chart XIII).....	67
Kauai District Office (Position Organization Chart XIII-A).....	68
Central Services Branch (Position Organization Chart XIII-B).....	69
State Foundation on Culture and the Arts (Organization Chart XIV).....	70
State Foundation on Culture and the Arts (Position Organization Chart XIV-A).....	71
Designated Programs, Art in Public Places, Support Services (Position Organization Chart XIV-B).....	72
King Kamehameha Celebration Commission (Organization Chart XV).....	73
King Kamehameha Celebration Commission (Position Organization Chart XV-A).....	74
Stadium Authority (Organization Chart XVI).....	75
Office of the Manager (Position Organization Chart XVI-A).....	76
Administrative Services Office (Position Organization Chart XVI-B).....	77
Events Management Branch (Position Organization Chart XVI-C).....	78
Engineering and Maintenance Management Branch (Position Organization Chart XVI-D).....	79
Building Construction and Maintenance Branch (Position Organization Chart XVI-E).....	80
General Services Section (Position Organization Chart XVI-F).....	81
Box Office Management Branch (Position Organization Chart XVI-G).....	82
Security Management Branch (Position Organization Chart XVI-H).....	83
Procurement Policy Board (Organization Chart XVII).....	84
State Procurement Office (Organization Chart XVIII).....	85
State Procurement Office (Position Organization Chart XVIII-A).....	86
Office of Elections (Organization Chart XXIV).....	87
Office of Elections (Position Organization Chart XXIV-A).....	88
Office of Elections, Reapportionment Commission (Position Organization Chart XXIV-B).....	89
Campaign Spending Commission (Organization Chart XXV).....	90
Campaign Spending Commission (Position Organization Chart XXV-A).....	91
Enhanced 911 Board (Organization Chart XXVI).....	92
Enhanced 911 Board (Organization Chart XXVI-A).....	93
State Building Code Council (Organization Chart XXVII).....	94
Information Privacy and Security Council (Organization Chart XXVIII).....	95
Access Hawaii Committee (Organization Chart XXVIV).....	96
Office of Information Practices (Organization Chart XXVVI).....	97
Office of Information Practices (Position Organization Chart XXVVI-A).....	98

STATE OF HAWAII  
DEPARTMENT OF ACCOUNTING AND GENERAL SERVICES

ORGANIZATION CHART

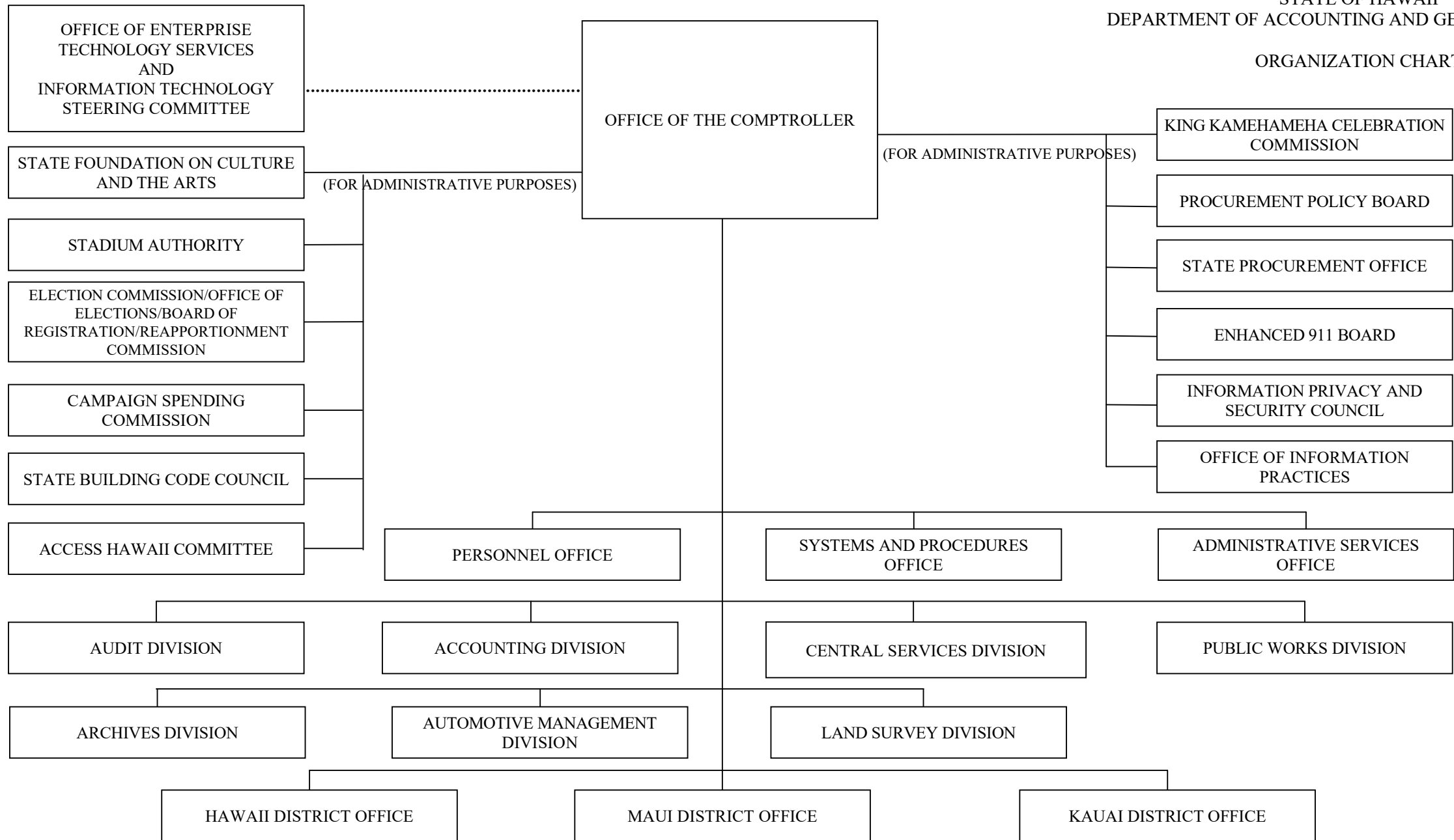

STATE OF HAWAII  
DEPARTMENT OF ACCOUNTING AND GENERAL SERVICES  
DEPARTMENT ADMINISTRATION

ORGANIZATION CHART

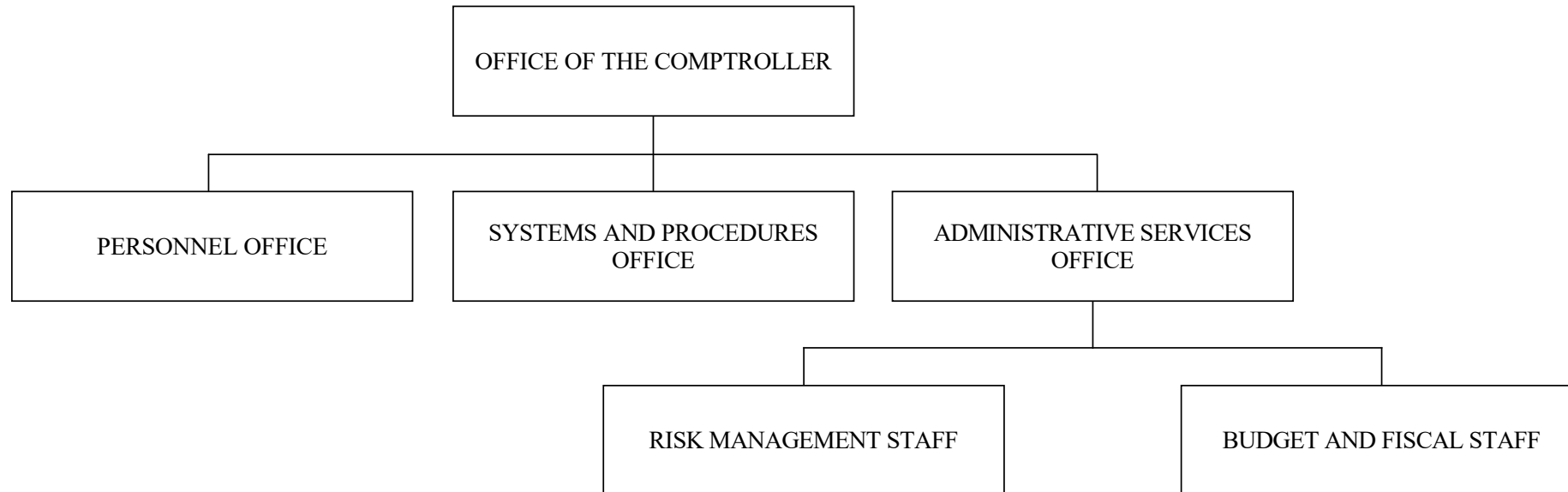

STATE OF HAWAII  
DEPARTMENT OF ACCOUNTING AND GENERAL SERVICES  
DEPARTMENT ADMINISTRATION

POSITION ORGANIZATION CHART

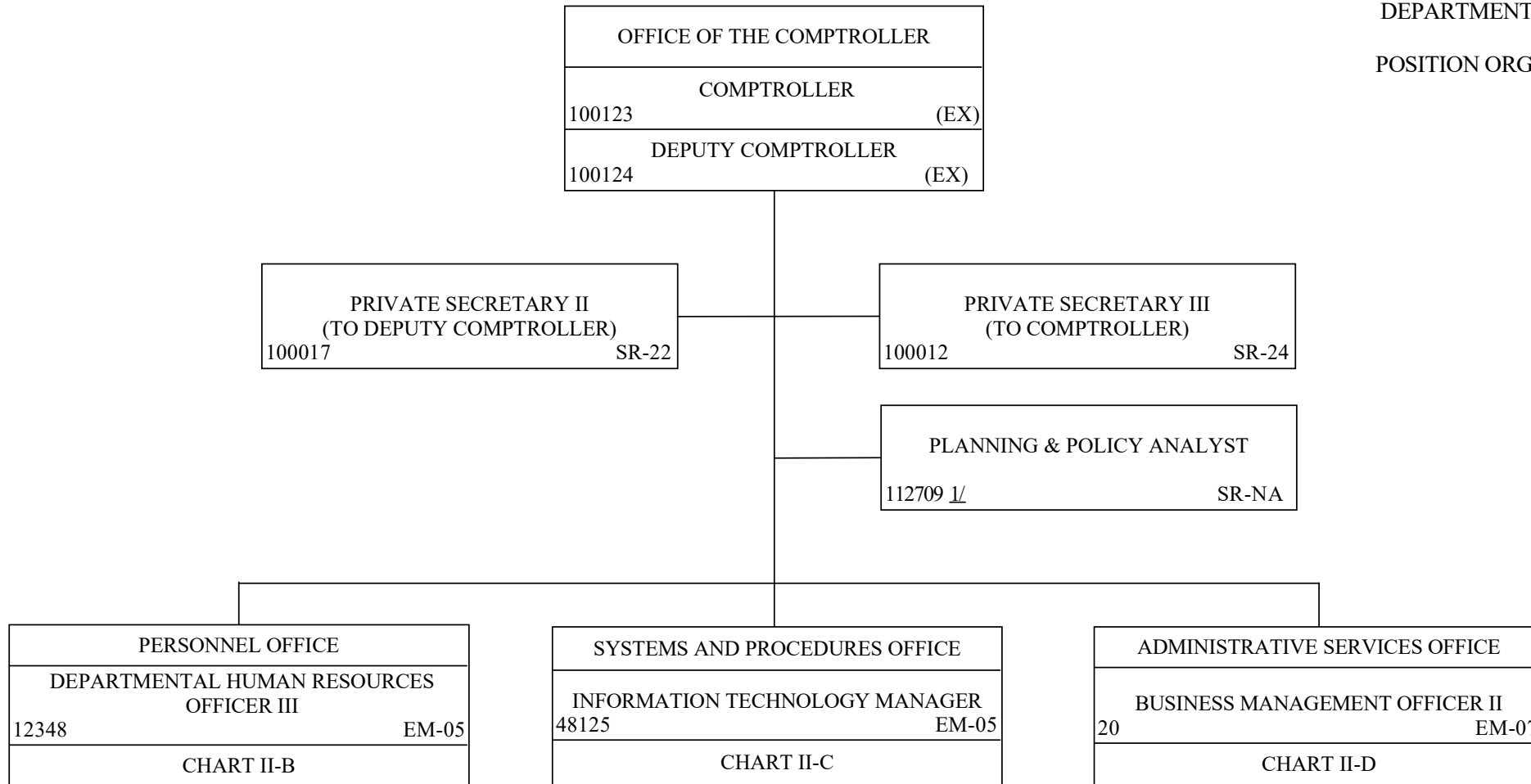

1/ ACT 53, SLH 2018, AUTHORIZED THE TRANSFER OF TEMPORARY EXEMPT POSITION NO. 112709, SR-NA, FROM A PUBLIC WORKS TEMPORARY CIP STAFF POSITION TO A COMPTROLLER'S OFFICE TEMPORARY POSITION.



STATE OF HAWAII  
DEPARTMENT OF ACCOUNTING AND GENERAL SERVICES  
DEPARTMENT ADMINISTRATION  
PERSONNEL OFFICE

POSITION ORGANIZATION CHART

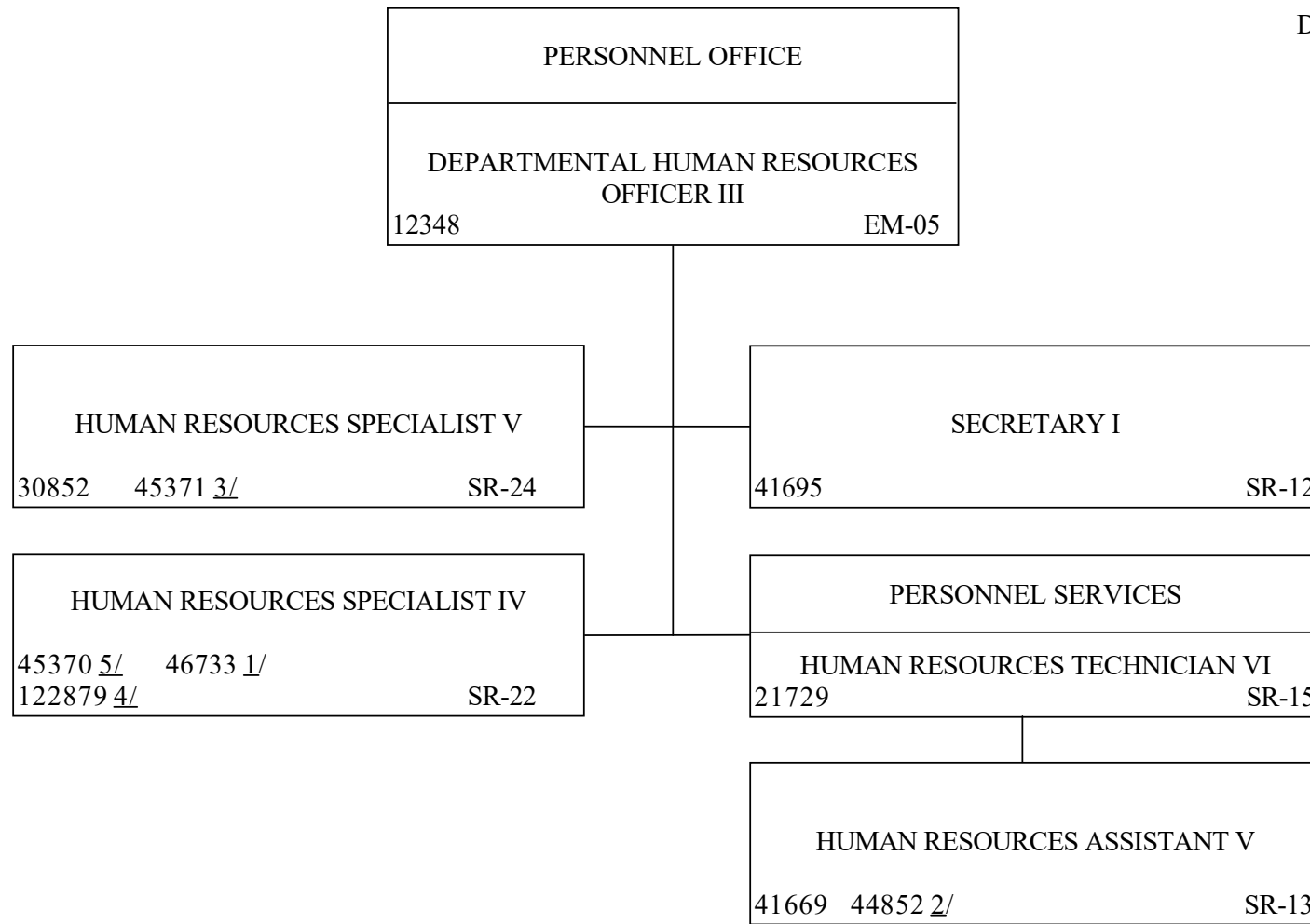

1/ POSITION NO. 46733 FUNDED BY INTER-DEPARTMENTAL TRANSFERS FUND (U), REALLOCATED TEMPORARILY TO HUMAN RESOURCES SPECIALIST I, SR-16, EFFECTIVE 5/16/18.

2/ POSITION NO. 44852 REALLOCATED BACK TO HUMAN RESOURCES ASSISTANT V, SR-13, EFFECTIVE 04/01/21.

3/ POSITION NO. 45371 REALLOCATED TEMPORARILY TO HUMAN RESOURCES SPECIALIST IV, SR-22, EFFECTIVE 03/01/21.

4/ POSITION NO. 122879 REALLOCATED TEMPORARILY TO HUMAN RESOURCES SPECIALIST III, SR-20, EFFECTIVE 01/16/21.

5/ POSITION NO. 45370 REALLOCATED TEMPORARILY TO HUMAN RESOURCES SPECIALIST II, SR-18, EFFECTIVE 05/01/19.

STATE OF HAWAII  
 DEPARTMENT OF ACCOUNTING AND GENERAL SERVICES  
 DEPARTMENT ADMINISTRATION  
 SYSTEMS AND PROCEDURES OFFICE

POSITION ORGANIZATION CHART

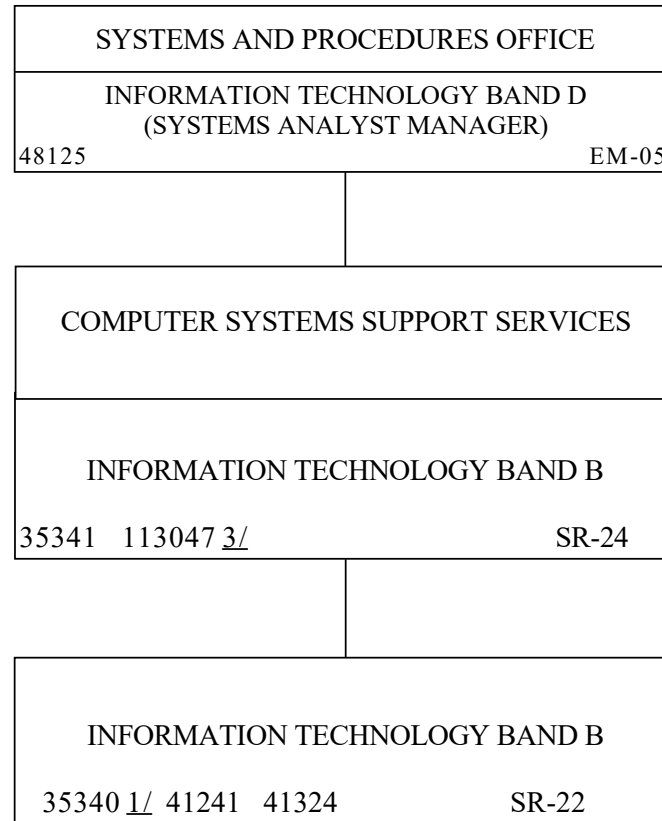

1/ POSITION NO. 35340, REALLOCATED TO AUTHORIZED INFORMATION TECHNOLOGY BAND B, SR-22, EFFECTIVE 10/16/19.

STATE OF HAWAII  
DEPARTMENT OF ACCOUNTING AND GENERAL SERVICES  
DEPARTMENT ADMINISTRATION  
ADMINISTRATIVE SERVICES OFFICE

POSITION ORGANIZATION CHART

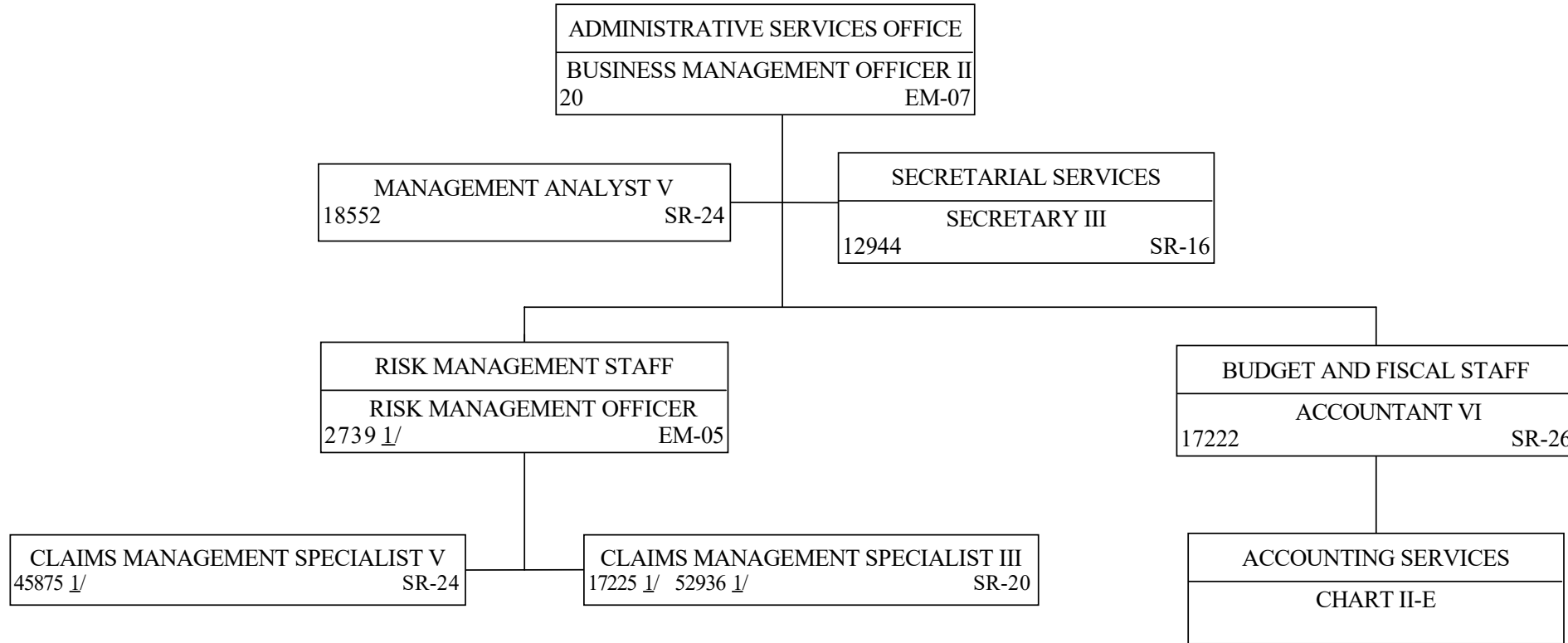

1/ POSITIONS ARE FUNDED BY REVOLVING FUNDS.

STATE OF HAWAII  
 DEPARTMENT OF ACCOUNTING AND GENERAL SERVICES  
 DEPARTMENT ADMINISTRATION  
 ADMINISTRATIVE SERVICES OFFICE  
 ACCOUNTING SERVICES

POSITION ORGANIZATION CHART

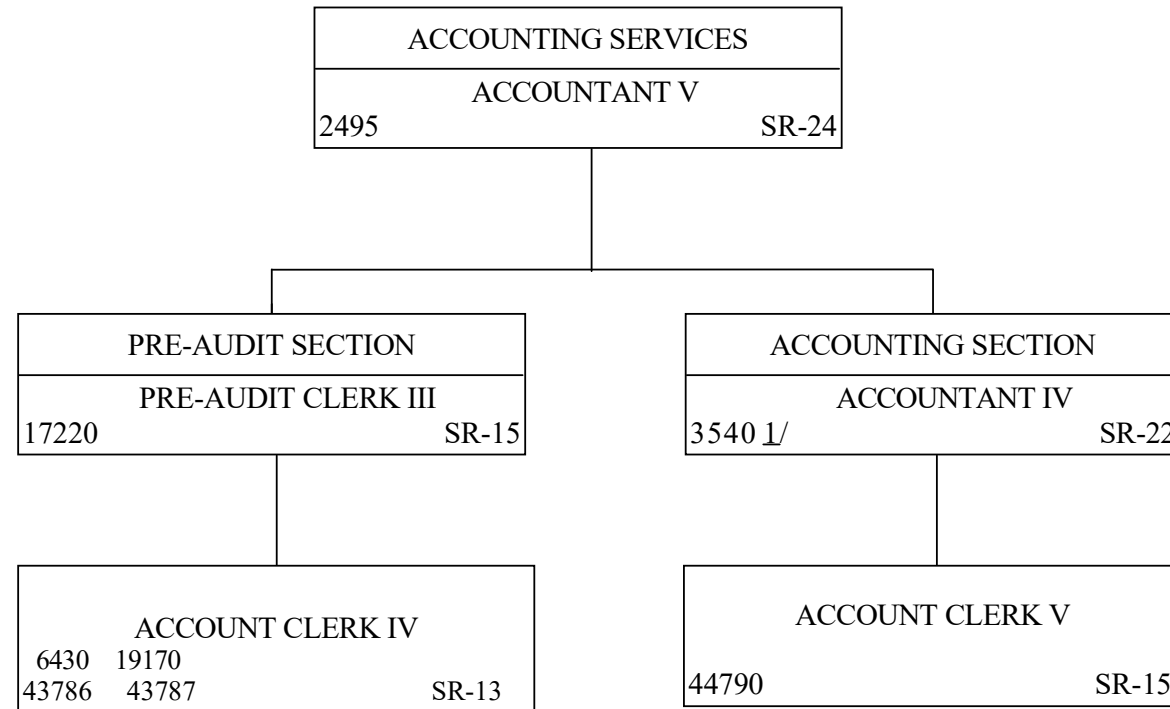

1/ REALLOCATED TEMPORARILY FROM AUTHORIZED ACCOUNTANT IV, SR-22, TO ACCOUNTANT III, SR-20, EFFECTIVE 02/16/21.

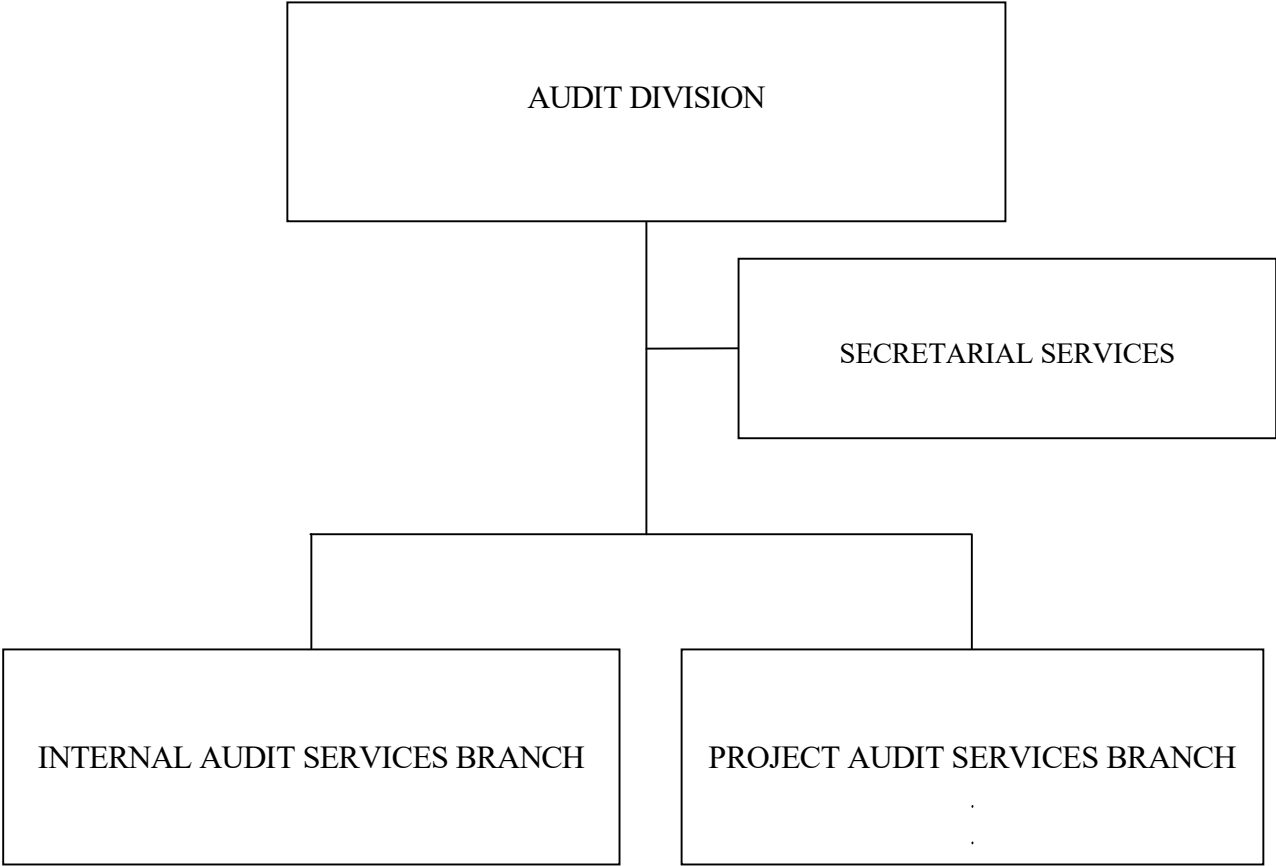

STATE OF HAWAII  
DEPARTMENT OF ACCOUNTING AND GENERAL SERVICES  
AUDIT DIVISION

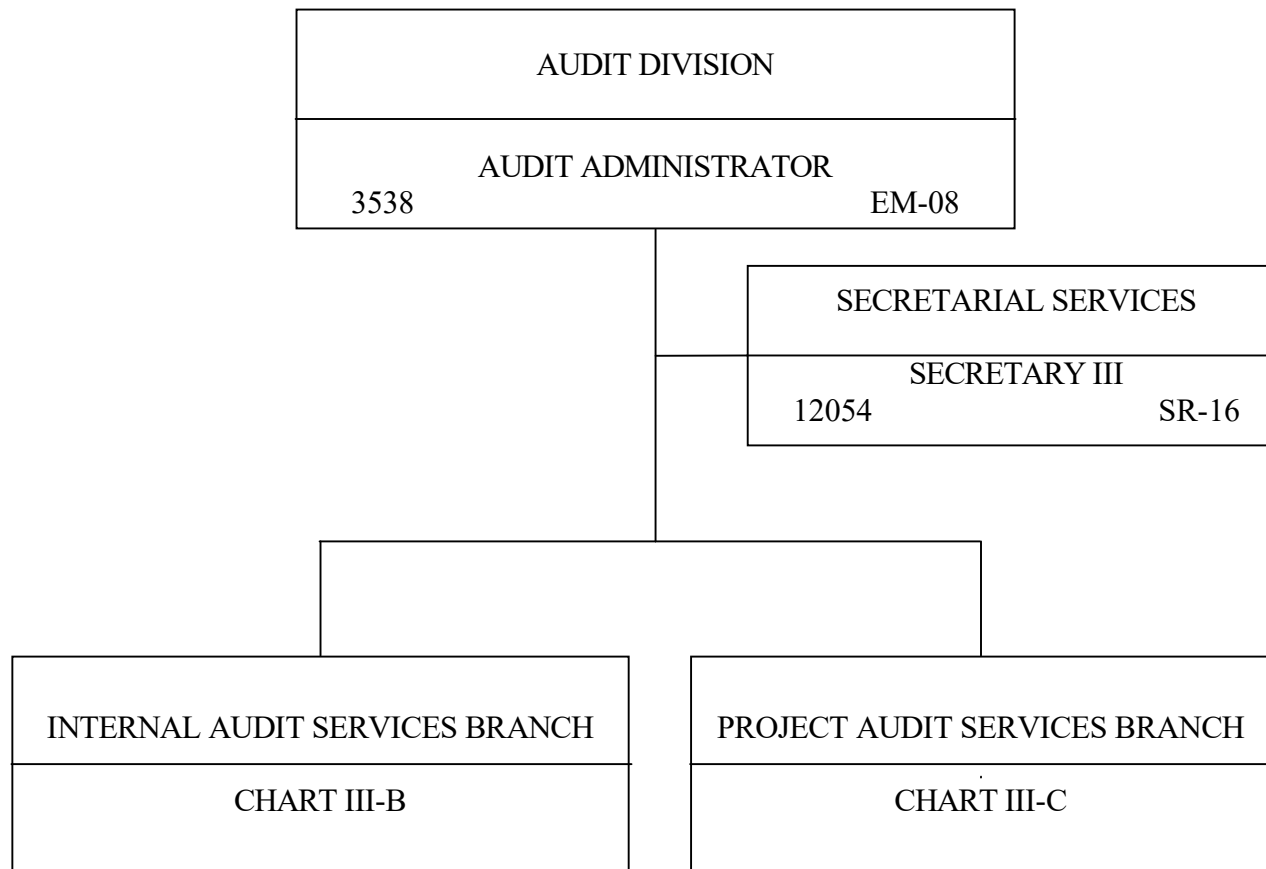

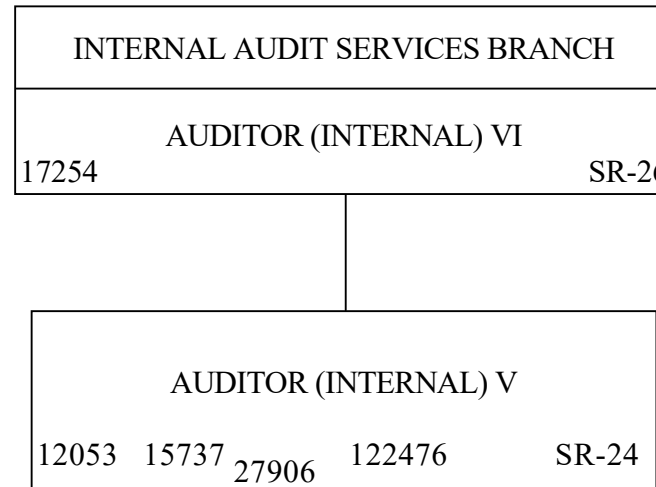

STATE OF HAWAII  
DEPARTMENT OF ACCOUNTING AND GENERAL SERVICES  
AUDIT DIVISION

POSITION ORGANIZATION CHART FOR NEW POSITIONS AUTHORIZED BY  
ACT 001, FIRST SPECIAL SESSION OF 2017 TO BE FORMALLY PLACED  
ON THE ORGANIZATION CHART WHEN THE REORGANIZATION IS COMPLETED.

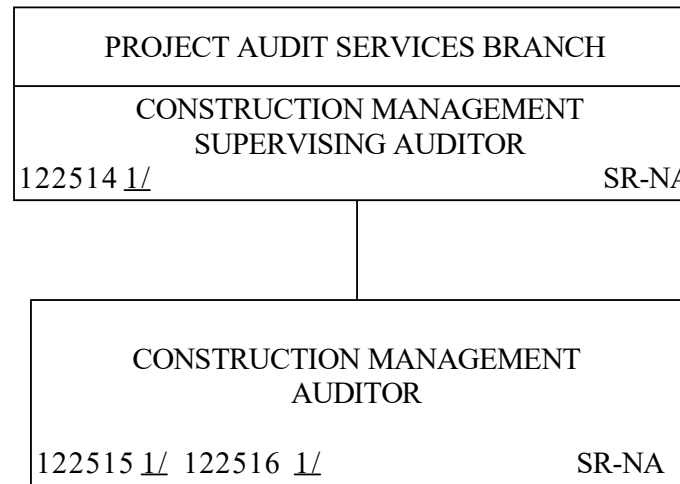

1/ AUTHORIZED BY ACT 001, FIRST SPECIAL SESSION OF 2017 (TO BE REPEALED DECEMBER 31, 2030). THE AUDIT DIVISION WILL DO A REORGANIZATION TO PLACE THESE POSITIONS WITHIN THE AUDIT DIVISION.



STATE OF HAWAII  
DEPARTMENT OF ACCOUNTING AND GENERAL SERVICES  
ACCOUNTING DIVISION

ORGANIZATION CHART

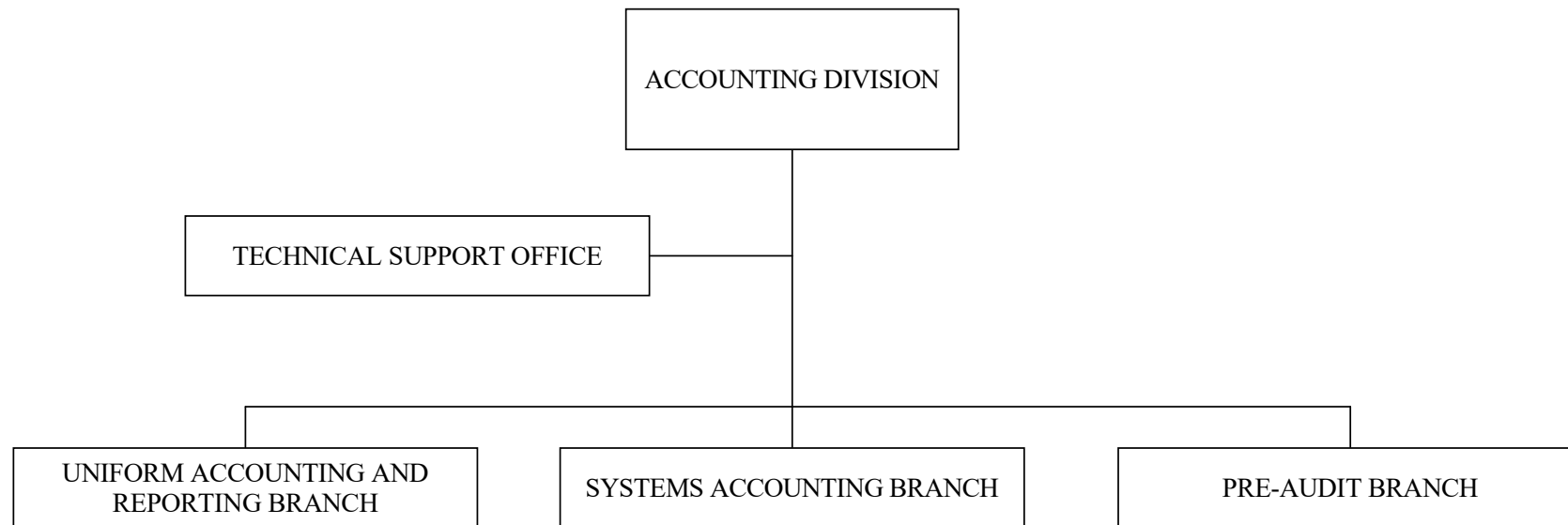

STATE OF HAWAII  
DEPARTMENT OF ACCOUNTING AND GENERAL SERVICES  
ACCOUNTING DIVISION

POSITION ORGANIZATION CHART

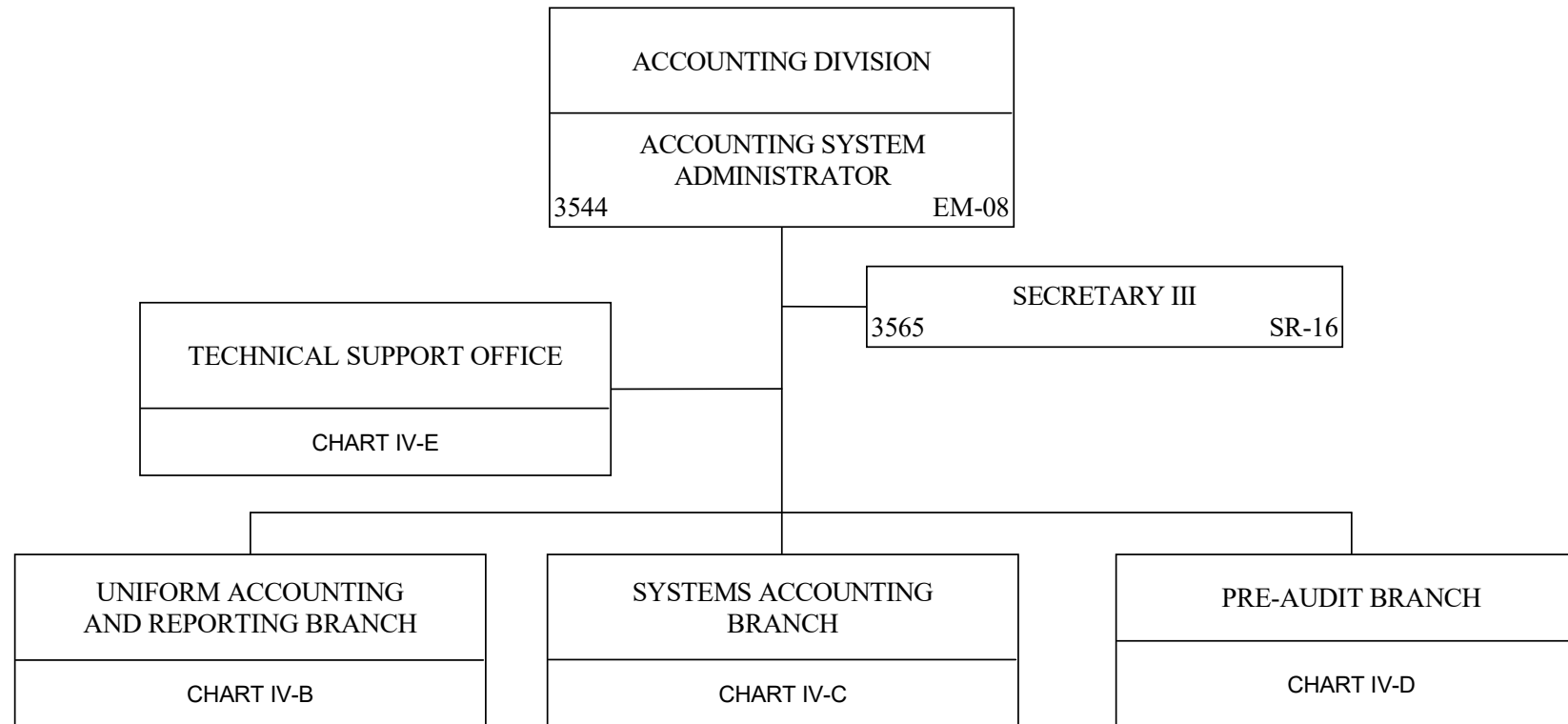

STATE OF HAWAII  
DEPARTMENT OF ACCOUNTING AND GENERAL SERVICES  
ACCOUNTING DIVISION  
UNIFORM ACCOUNTING AND REPORTING BRANCH

POSITION ORGANIZATION CHART

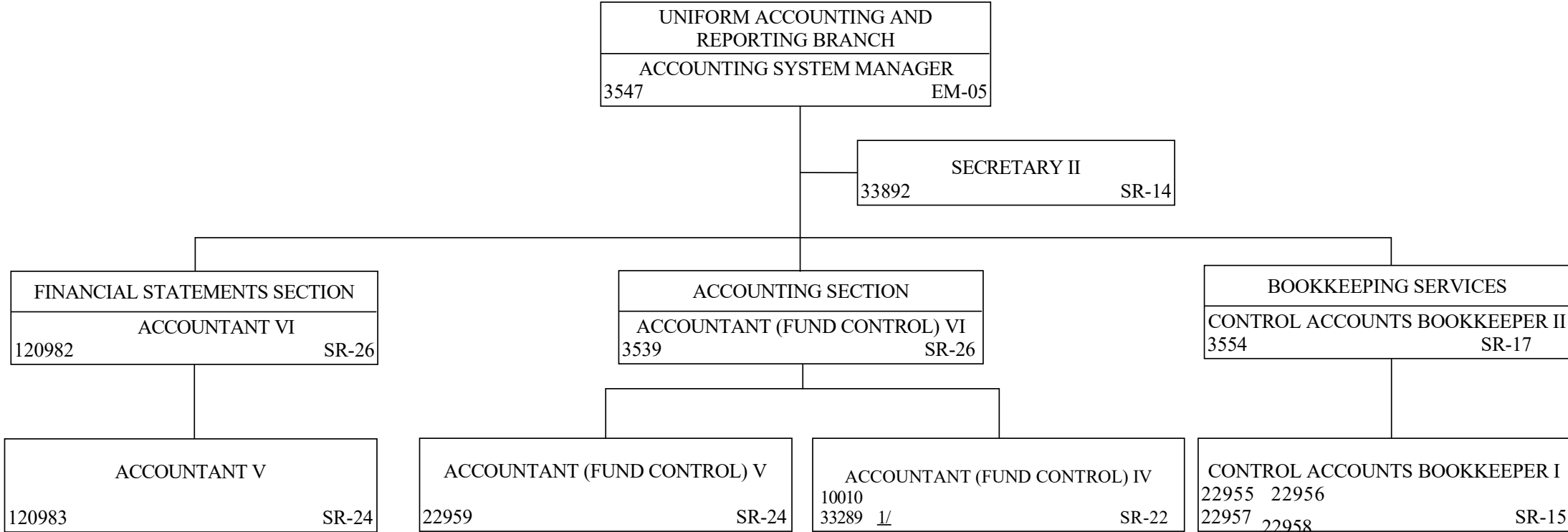

1/ POSITION NO. 33289 WAS REALLOCATED BACK TO THE AUTHORIZED ACCOUNTANT IV, SR-22, FROM ACCOUNTANT III, SR-20, EFFECTIVE 06/01/21.

STATE OF HAWAII  
 DEPARTMENT OF ACCOUNTING AND GENERAL SERVICES  
 ACCOUNTING DIVISION  
 SYSTEMS ACCOUNTING BRANCH  
 POSITION ORGANIZATION CHART

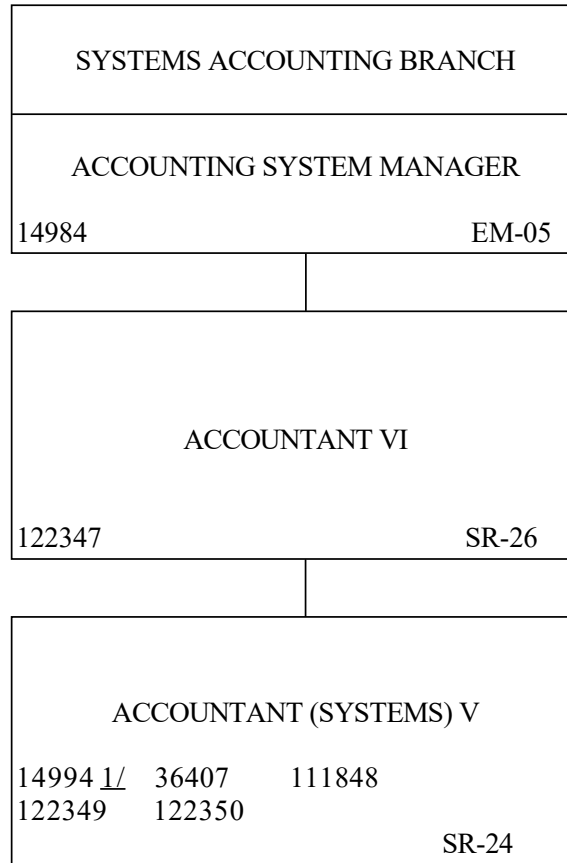

1/ POSITION REALLOCATED TEMPORARILY TO AN ACCOUNTANT IV, SR-22, EFFECTIVE 11/20/19.

STATE OF HAWAII  
DEPARTMENT OF ACCOUNTING AND GENERAL SERVICES  
ACCOUNTING DIVISION  
PRE-AUDIT BRANCH

POSITION ORGANIZATION CHART

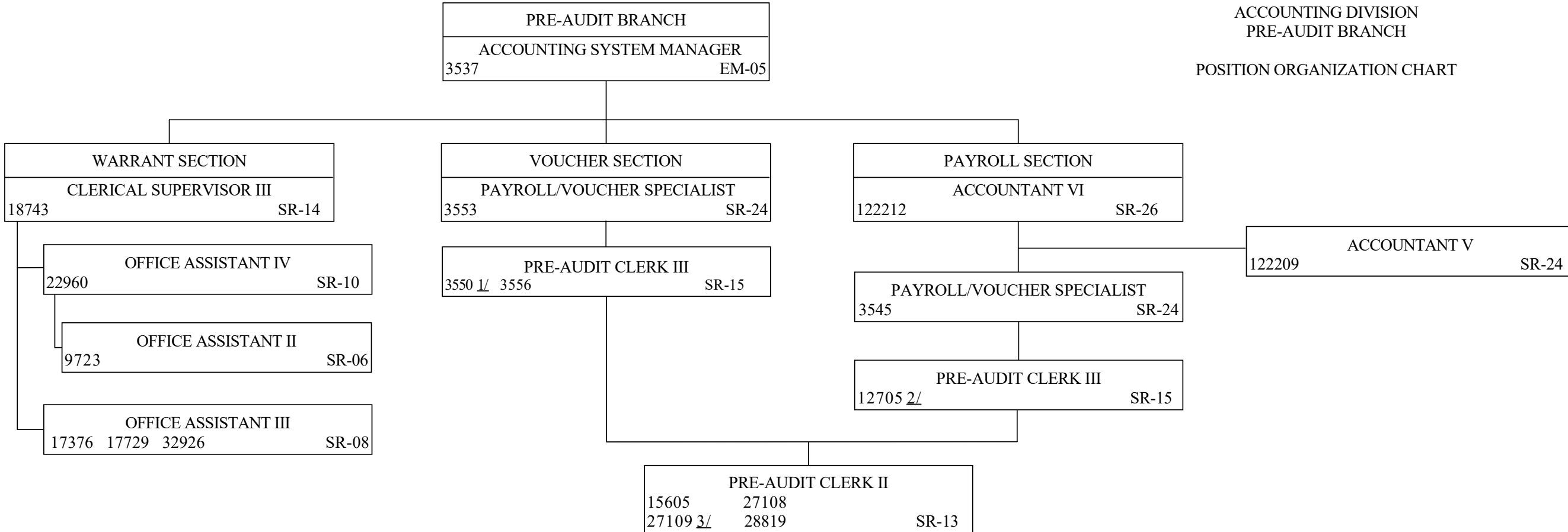

1/ POSITION NO. 3550 WAS REALLOCATED TEMPORARILY FROM PRE-AUDIT CLERK III, SR-15 TO PRE-AUDIT CLERK II, SR-13, EFFECTIVE 12/24/18.

2/ POSITION NO. 12705 WAS REALLOCATED TEMPORARILY FROM PRE-AUDIT CLERK III, SR-15, TO PRE-AUDIT CLERK II, SR-13, EFFECTIVE 01/12/21.

3/ POSITION NO. 27109 WAS REALLOCATED TEMPORARILY FROM PRE-AUDIT CLERK II, SR-13, TO PRE-AUDIT CLERK I, SR-11, EFFECTIVE 01/12/21.

STATE OF HAWAII  
 DEPARTMENT OF ACCOUNTING AND GENERAL SERVICES  
 ACCOUNTING DIVISION  
 TECHNICAL SUPPORT OFFICE

POSITION ORGANIZATION CHART

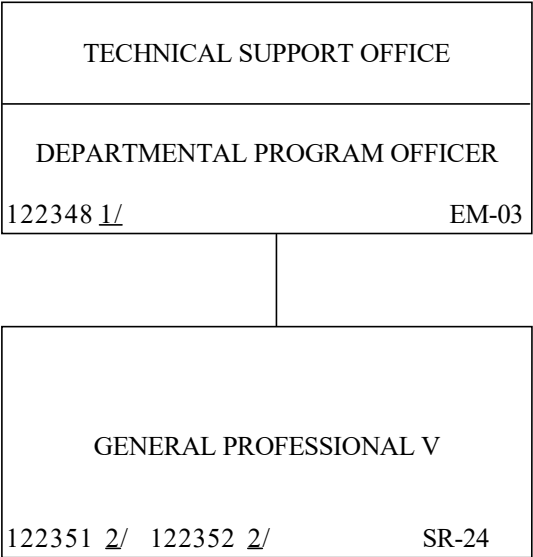

1/ POSITION NO. 122348 RECLASSIFIED TO DEPARTMENTAL PROGRAM OFFICER, EM-03, FROM INFORMATION TECHNOLOGY BAND D (SYSTEMS ANALYSIS MANAGER, EM-05 PREVIOUSLY ACCOUNTANT VI) EFFECTIVE 7/22/20 AND PENDING DELEGATED REORGANIZATION FROM THE TECHNICAL SUPPORT OFFICE BACK TO THE SYSTEMS ACCOUNTING OFFICE.

2/ RECLASSIFIED TO GENERAL PROFESSIONAL V, SR-24, FROM INFORMATION TECHNOLOGY BAND B (SYSTEM ANALYST, SR-24 PREVIOUSLY ACCOUNTANT V) EFFECTIVE 7/14/20 AND PENDING DELEGATED REORGANIZATION FROM THE TECHNICAL SUPPORT OFFICE BACK TO THE SYSTEMS ACCOUNTING OFFICE.

STATE OF HAWAII  
DEPARTMENT OF ACCOUNTING AND GENERAL SERVICES  
OFFICE OF ENTERPRISE TECHNOLOGY SERVICES  
AND  
INFORMATION TECHNOLOGY STEERING COMMITTEE

ORGANIZATION CHART

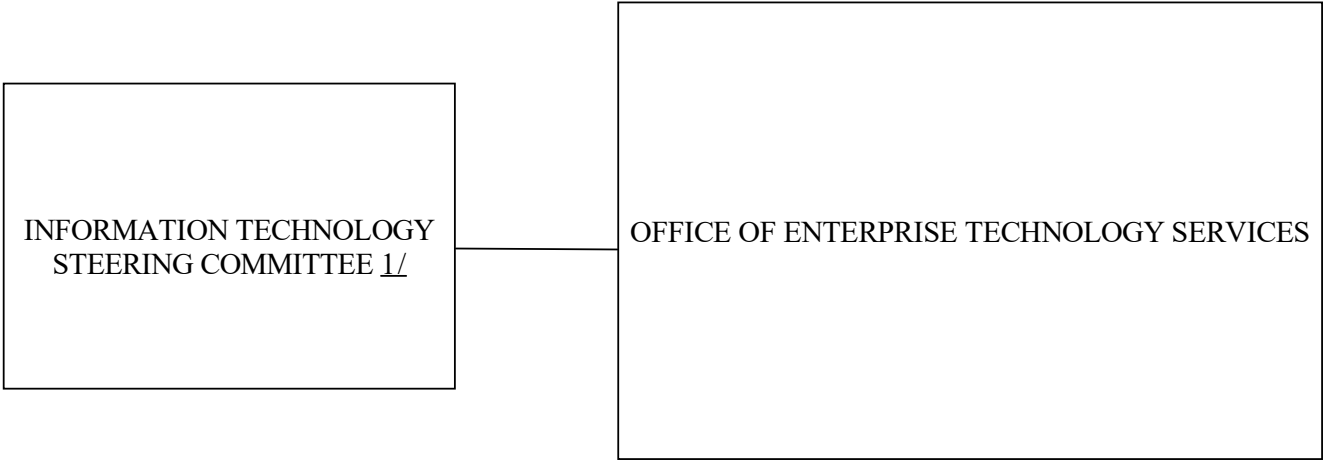

1/ ESTABLISHED TO ASSIST THE CHIEF INFORMATION OFFICER (CIO) IN DEVELOPING THE STATE'S INFORMATION TECHNOLOGY STANDARDS AND POLICIES. THE CIO CHAIRS THIS COMMITTEE.

STATE OF HAWAII  
DEPARTMENT OF ACCOUNTING AND GENERAL SERVICES  
OFFICE OF ENTERPRISE TECHNOLOGY SERVICES

ORGANIZATION CHART

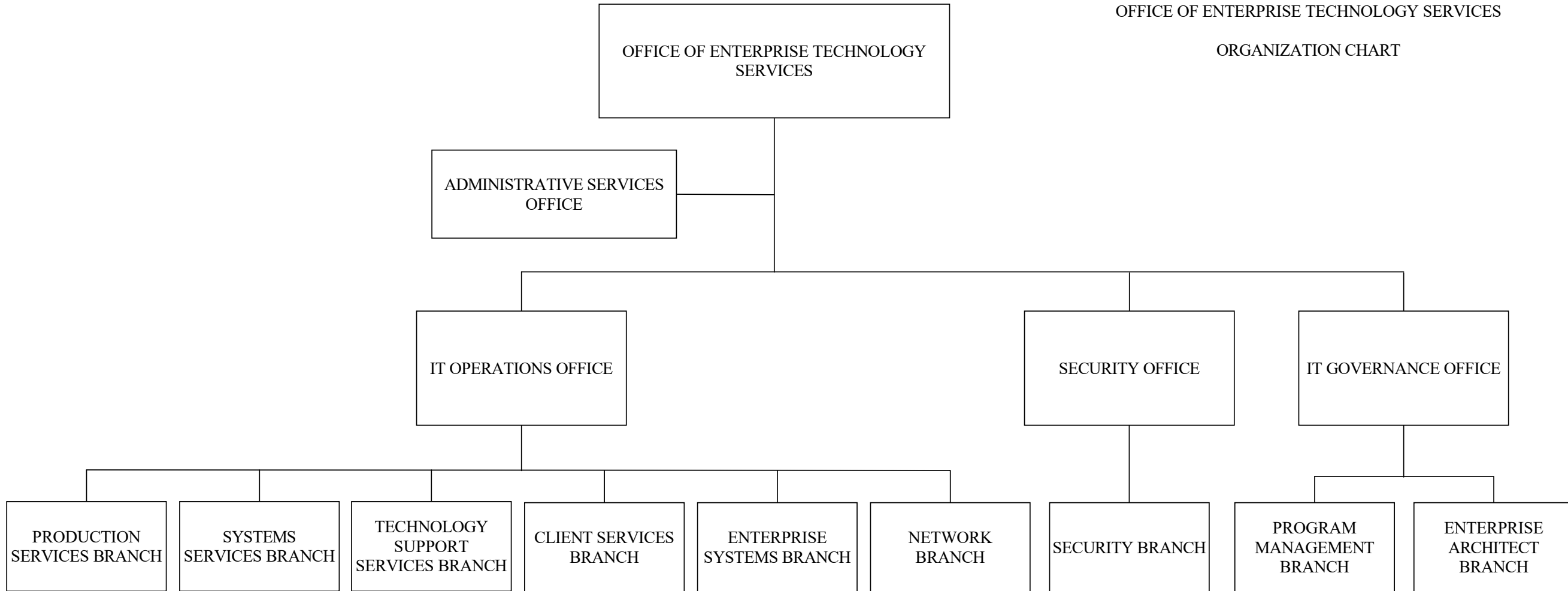



STATE OF HAWAII  
 DEPARTMENT OF ACCOUNTING AND GENERAL SERVICES  
 OFFICE OF ENTERPRISE TECHNOLOGY SERVICES

POSITION ORGANIZATION CHART

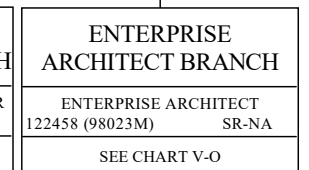
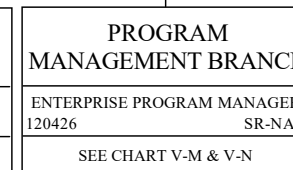
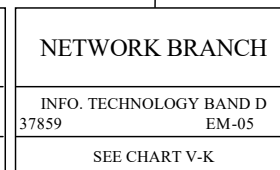
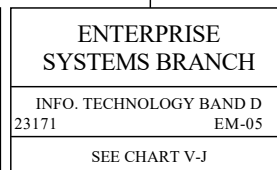
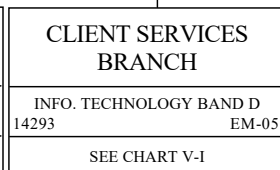
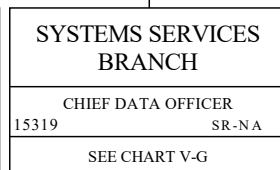
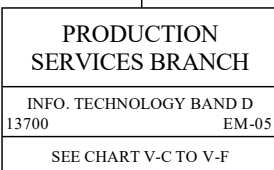
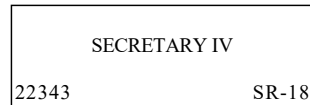
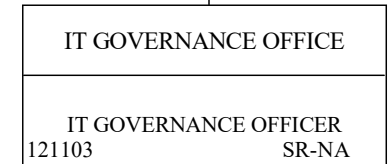
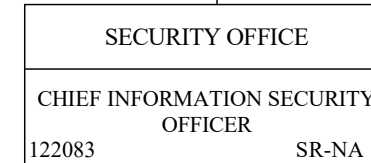
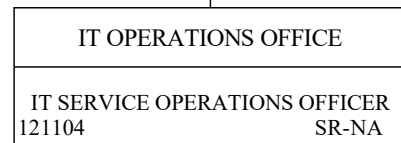
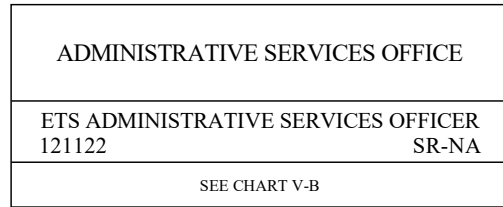
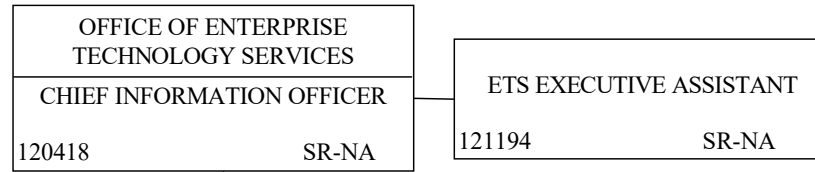

STATE OF HAWAII  
 DEPARTMENT OF ACCOUNTING AND GENERAL SERVICES  
 OFFICE OF ENTERPRISE TECHNOLOGY SERVICES  
 ADMINISTRATIVE SERVICES OFFICE

POSITION ORGANIZATION CHART

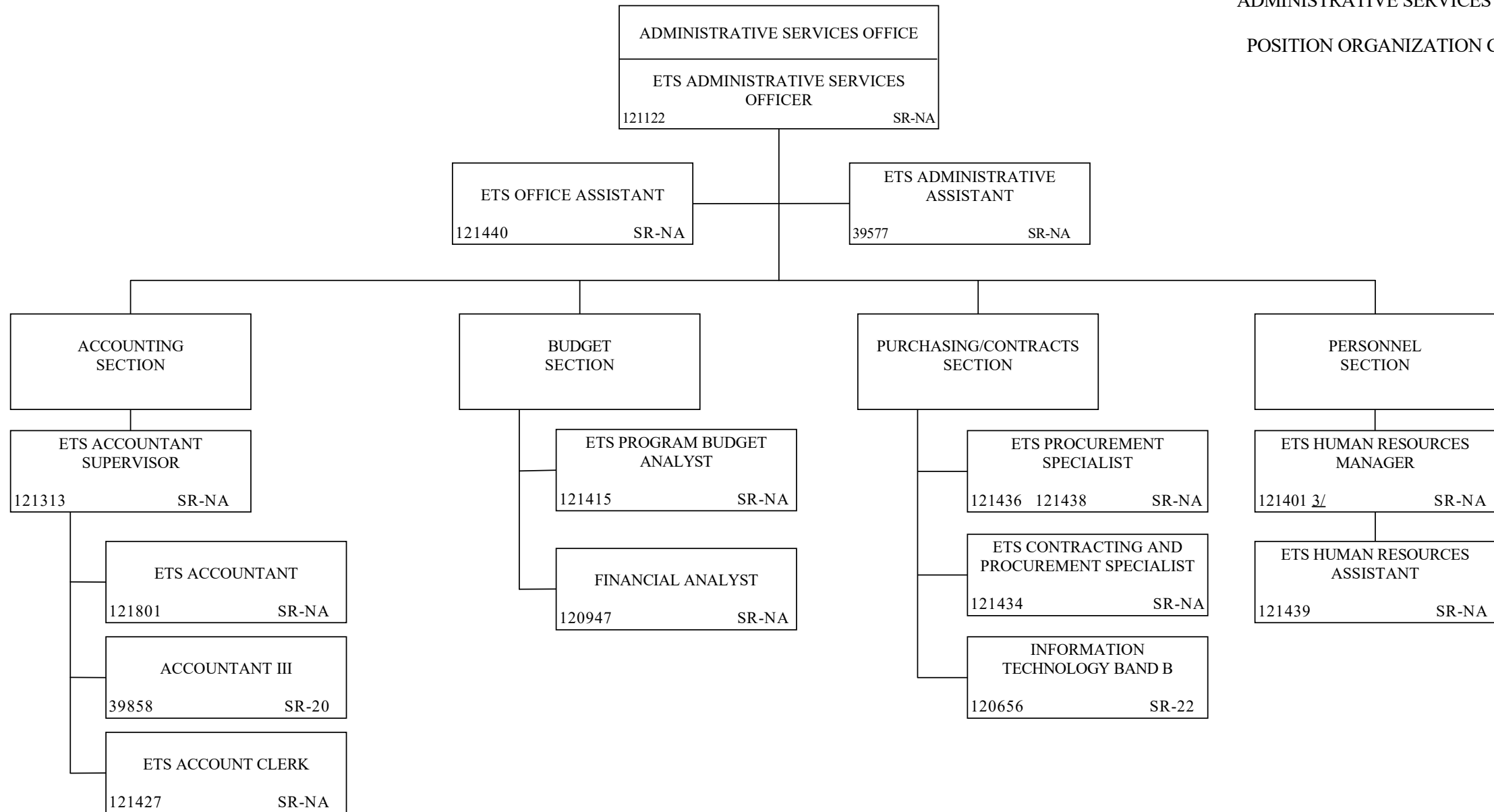

STATE OF HAWAII  
 DEPARTMENT OF ACCOUNTING AND GENERAL SERVICES  
 OFFICE OF ENTERPRISE TECHNOLOGY SERVICES  
 IT OPERATIONS OFFICE  
 PRODUCTION SERVICES BRANCH  
 POSITION ORGANIZATION CHART

PRODUCTION SERVICES BRANCH	
INFORMATION TECHNOLOGY BAND D 13700	EM-05

SECRETARY II	
29673	SR-14

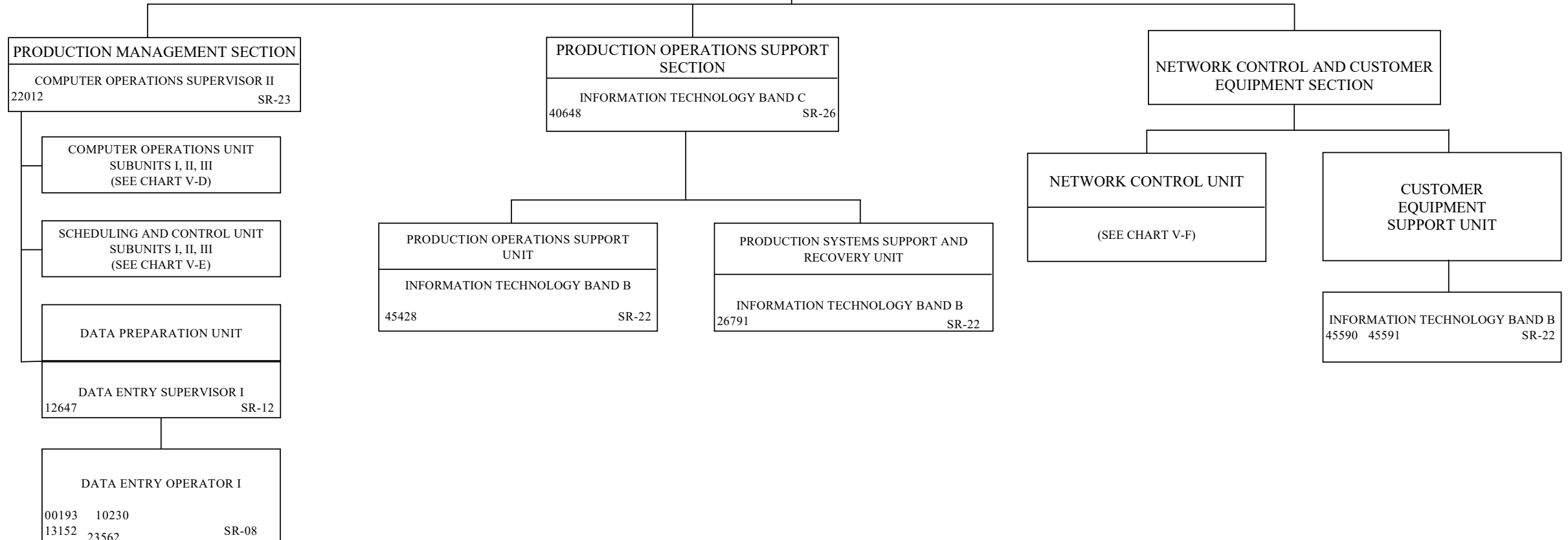

STATE OF HAWAII  
 DEPARTMENT OF ACCOUNTING AND GENERAL SERVICES  
 OFFICE OF ENTERPRISE TECHNOLOGY SERVICES  
 IT OPERATIONS OFFICE  
 PRODUCTION SERVICES BRANCH  
 PRODUCTION MANAGEMENT SECTION  
 COMPUTER OPERATIONS UNIT

POSITION ORGANIZATION CHART

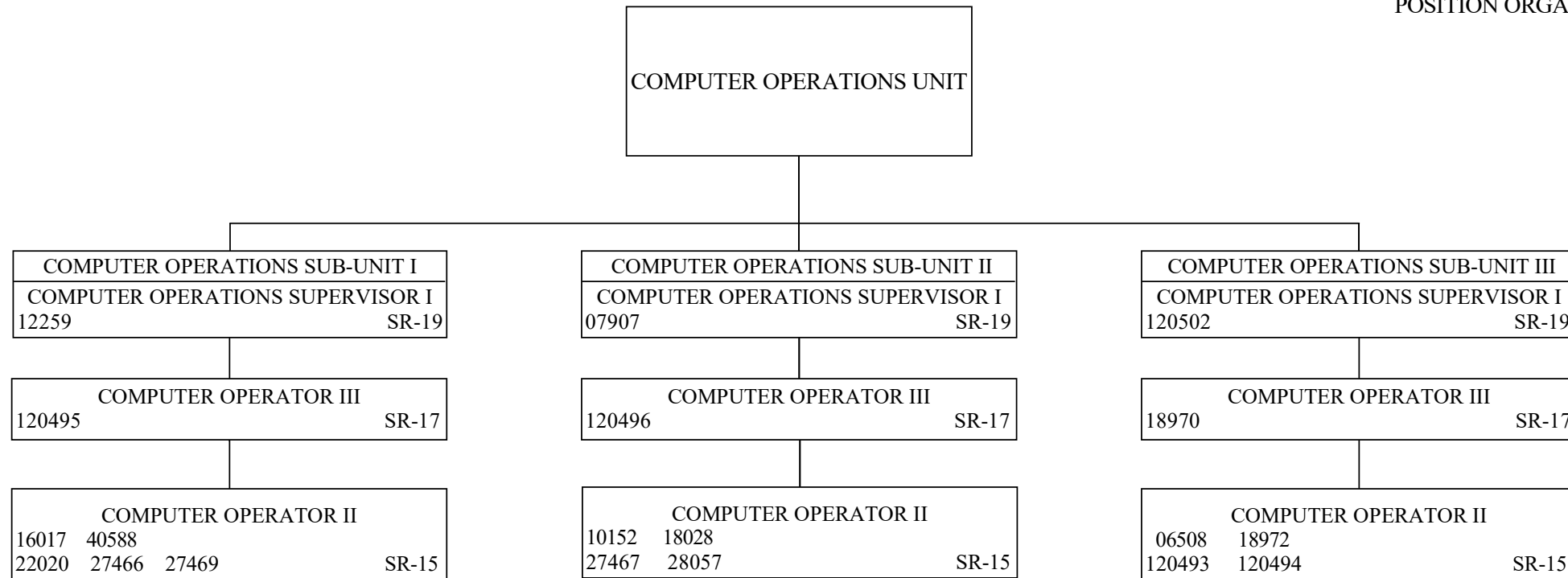

STATE OF HAWAII  
 DEPARTMENT OF ACCOUNTING AND GENERAL SERVICES  
 OFFICE OF ENTERPRISE TECHNOLOGY SERVICES  
 IT OPERATIONS OFFICE  
 PRODUCTION SERVICES BRANCH  
 PRODUCTION MANAGEMENT SECTION  
 SCHEDULING AND CONTROL UNIT  
  
 POSITION ORGANIZATION CHART

SCHEDULING AND CONTROL UNIT

SCHEDULING AND CONTROL SUB-UNIT I  
 DATA PROCESSING CONTROL CLERK II  
 19042 SR-14

SCHEDULING AND CONTROL SUB-UNIT II  
 DATA PROCESSING CONTROL CLERK II  
 41448 SR-14

SCHEDULING AND CONTROL SUB-UNIT III  
 DATA CENTER TECHNICIAN SUPERVISOR  
 14736 SR-NA

DATA CENTER TECHNICIAN  
 120510 120509 SR-NA

DATA PROCESSING CONTROL CLERK I  
 12377 27570 27571 SR-12

DATA CENTER TECHNICIAN  
 12378 SR-NA

DATA CENTER TECHNICIAN  
 120508 SR-NA

STATE OF HAWAII  
DEPARTMENT OF ACCOUNTING AND GENERAL SERVICES  
OFFICE OF ENTERPRISE TECHNOLOGY SERVICES  
IT OPERATIONS OFFICE  
PRODUCTION SERVICES BRANCH  
NETWORK CONTROL AND EQUIPMENT SUPPORT SECTION  
NETWORK CONTROL UNIT

POSITION ORGANIZATION CHART

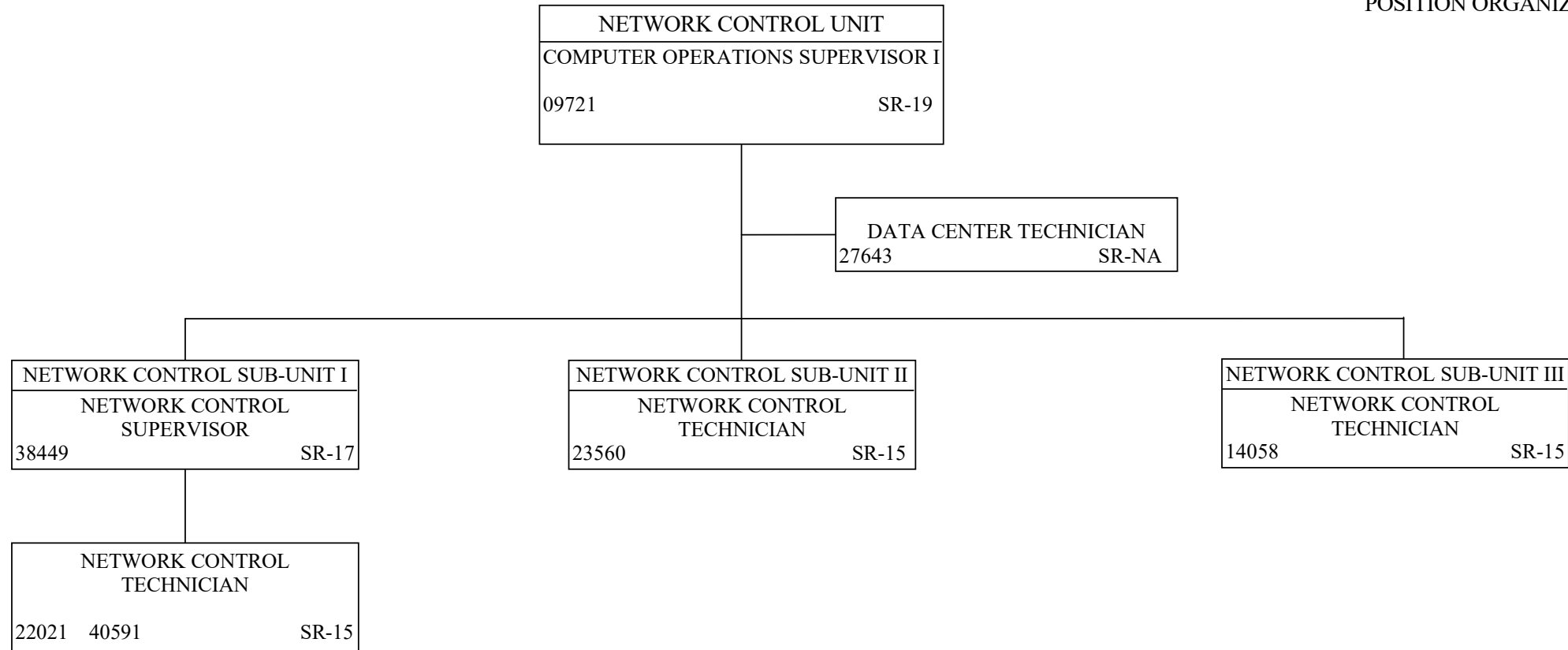

STATE OF HAWAII  
 DEPARTMENT OF ACCOUNTING AND GENERAL SERVICES  
 OFFICE OF ENTERPRISE TECHNOLOGY SERVICES  
 IT OPERATIONS OFFICE  
 SYSTEMS SERVICES BRANCH

POSITION ORGANIZATION CHART

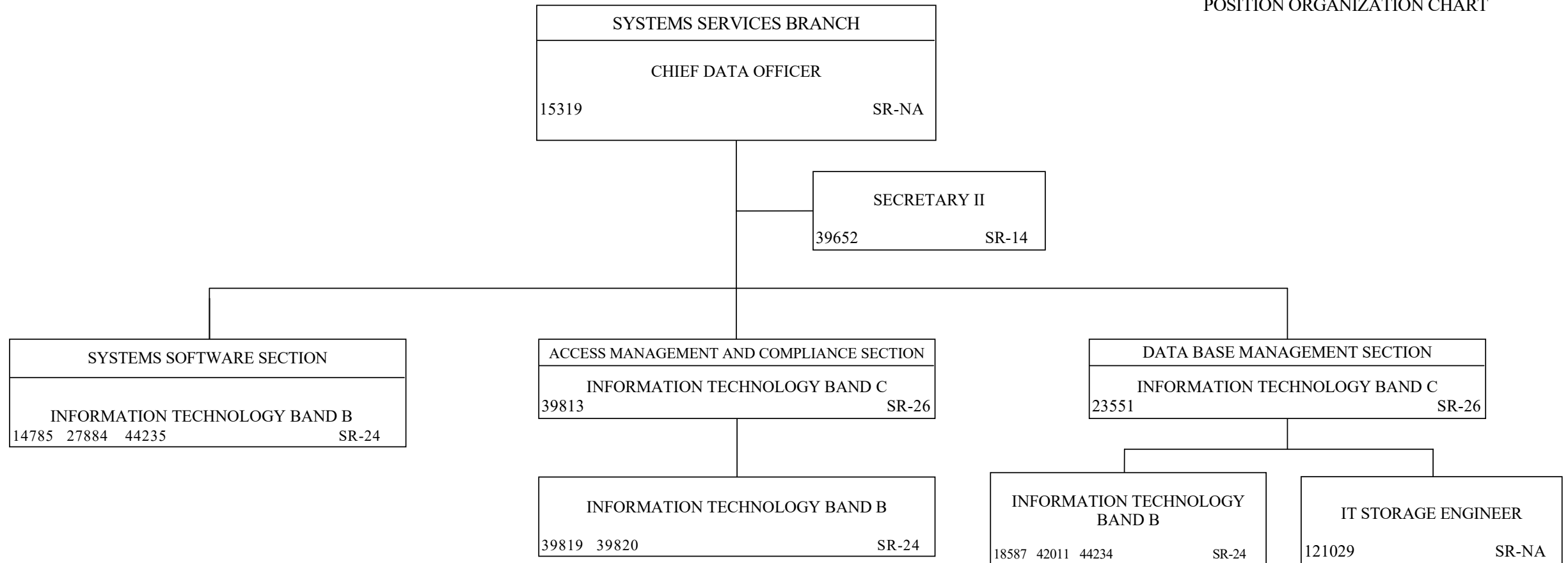

STATE OF HAWAII  
 DEPARTMENT OF ACCOUNTING AND GENERAL SERVICES  
 OFFICE OF ENTERPRISE TECHNOLOGY SERVICES  
 IT OPERATIONS OFFICE  
 TECHNOLOGY SUPPORT SERVICES BRANCH

POSITION ORGANIZATION CHART

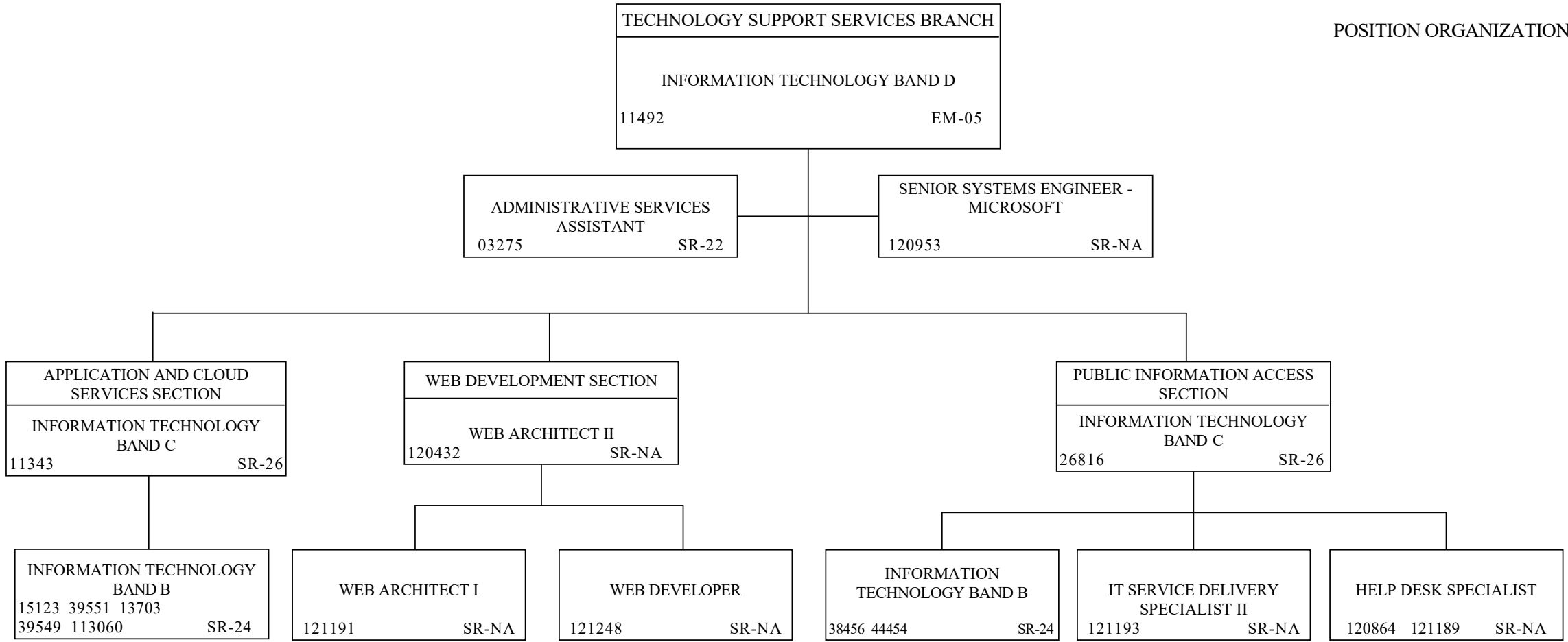



STATE OF HAWAII  
 DEPARTMENT OF ACCOUNTING AND GENERAL SERVICES  
 OFFICE OF ENTERPRISE TECHNOLOGY SERVICES  
 IT OPERATIONS OFFICE  
 CLIENT SERVICES BRANCH

POSITION ORGANIZATION CHART

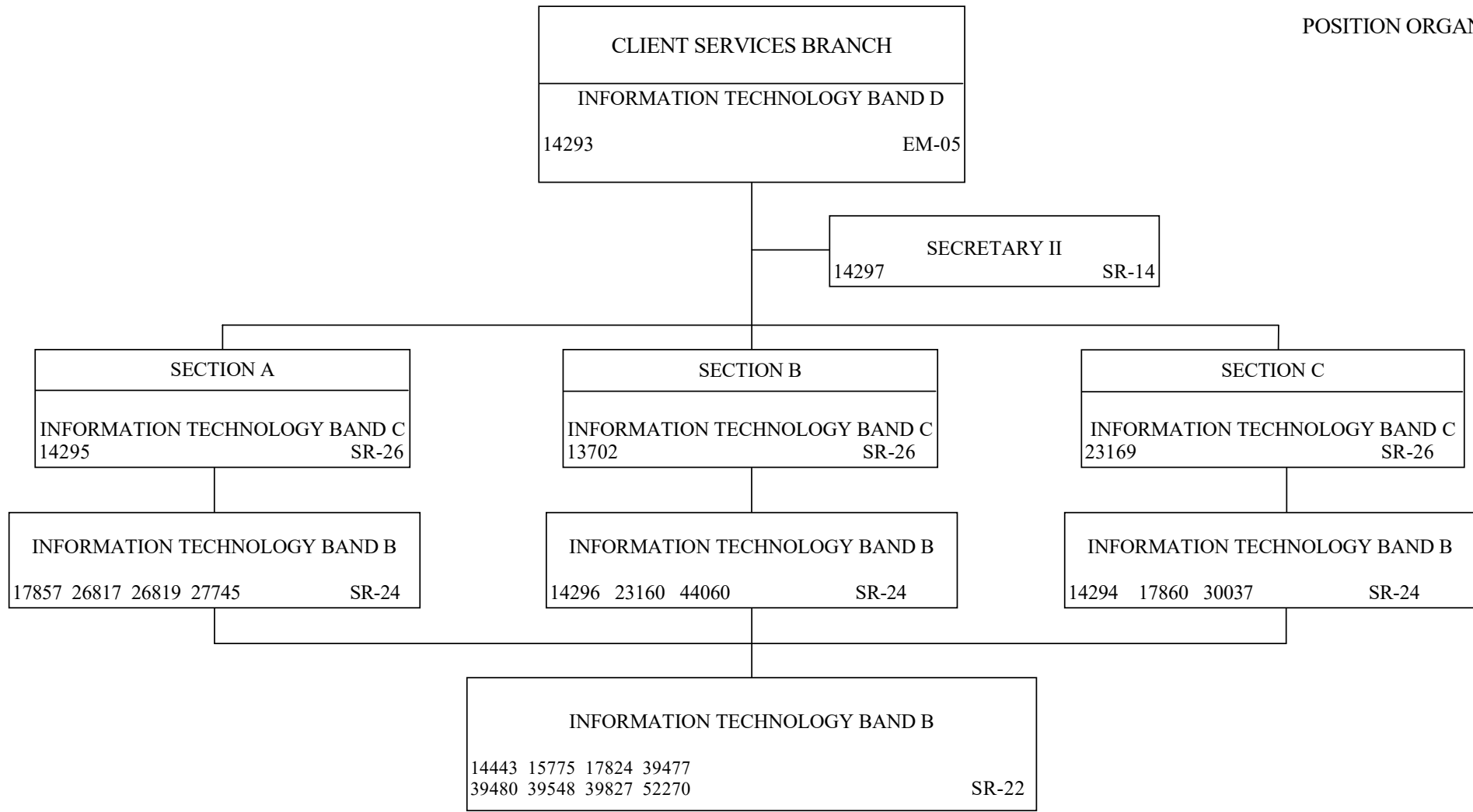

STATE OF HAWAII  
 DEPARTMENT OF ACCOUNTING AND GENERAL SERVICES  
 OFFICE OF ENTERPRISE TECHNOLOGY SERVICES  
 IT OPERATIONS OFFICE  
 ENTERPRISE SYSTEMS BRANCH  
 POSITION ORGANIZATION CHART

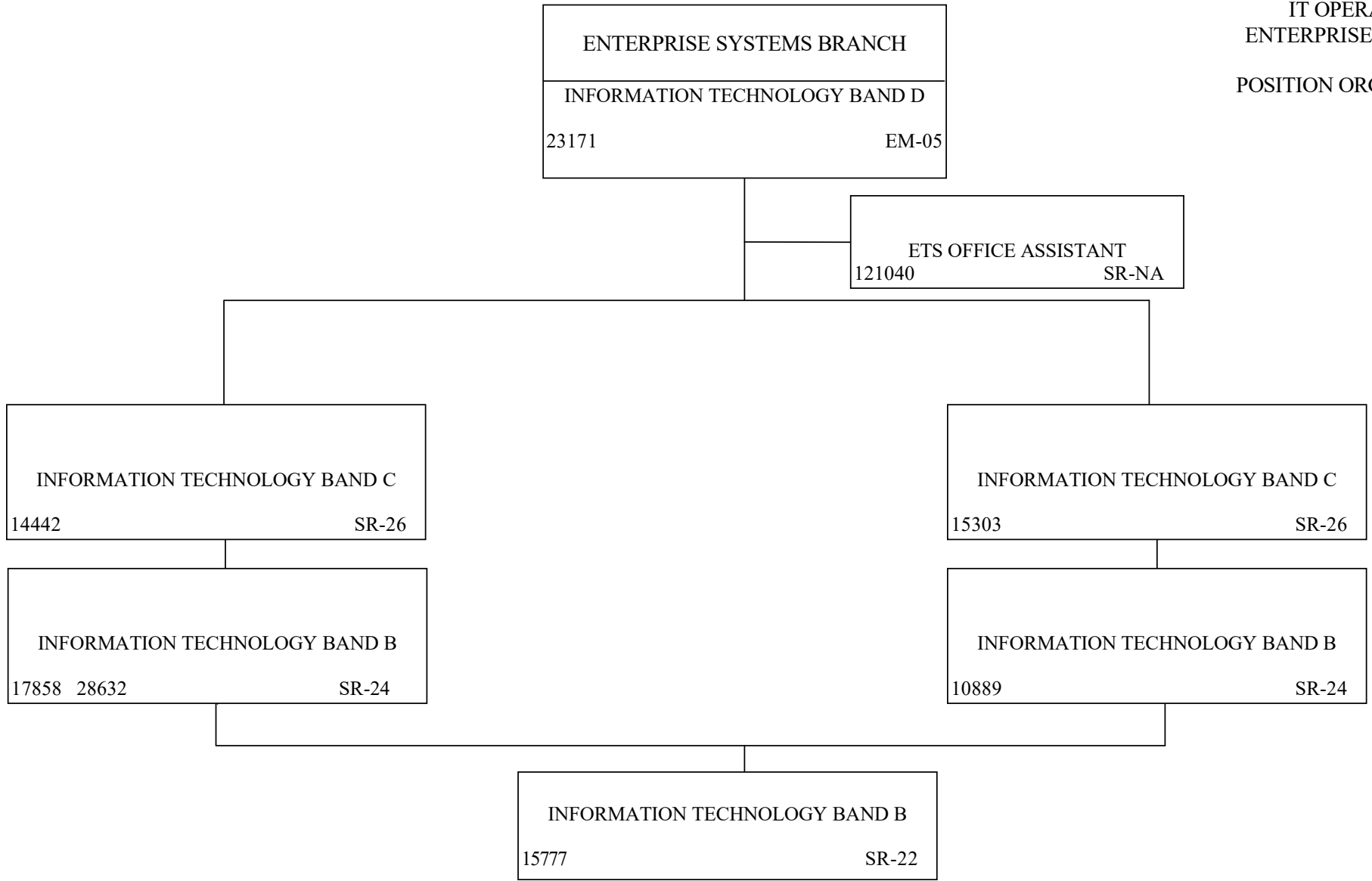

STATE OF HAWAII  
DEPARTMENT OF ACCOUNTING AND GENERAL SERVICES  
OFFICE OF ENTERPRISE TECHNOLOGY SERVICES  
IT OPERATIONS OFFICE  
NETWORK BRANCH

POSITION ORGANIZATION CHART

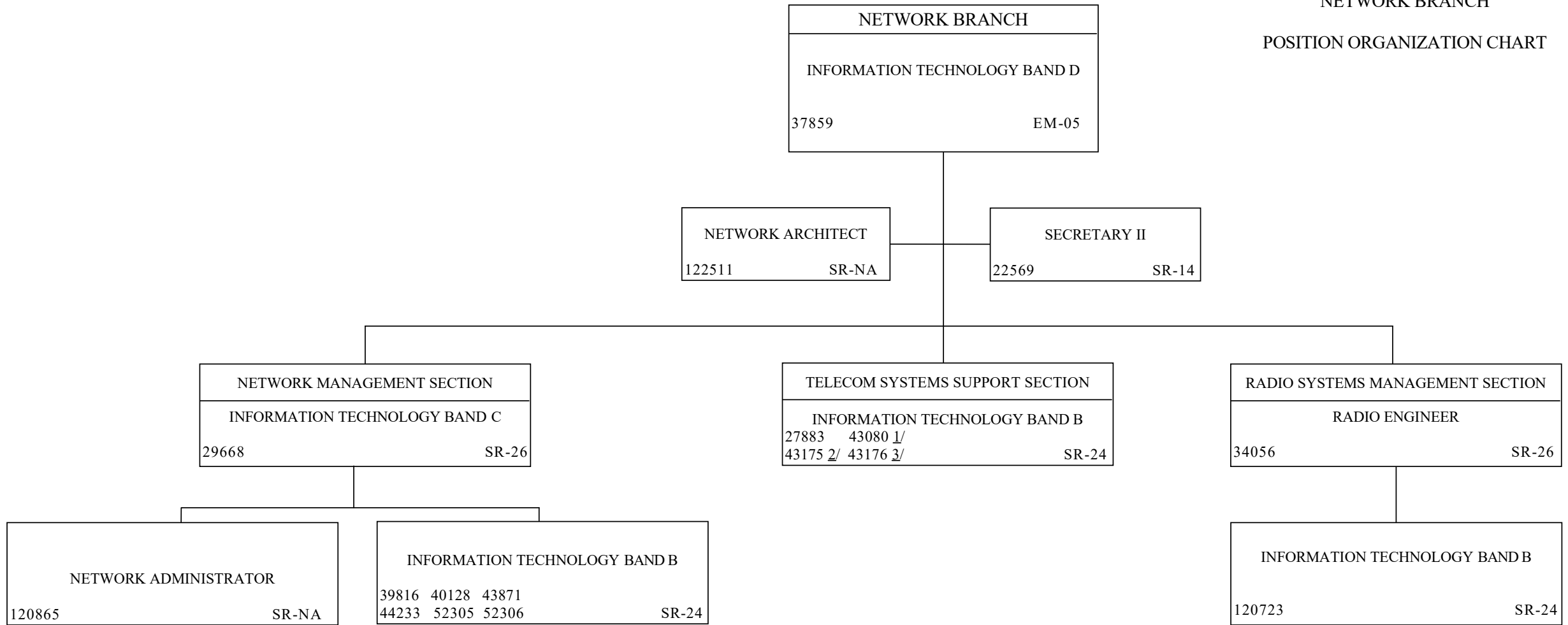

1/ POSITION NO. 43080 IS LOCATED ON KAUAI.  
2/ POSITION NO. 43175 IS LOCATED ON MAUI.  
3/ POSITION NO. 43176 IS LOCATED ON HAWAII.

STATE OF HAWAII  
 DEPARTMENT OF ACCOUNTING AND GENERAL SERVICES  
 OFFICE OF ENTERPRISE TECHNOLOGY SERVICES  
 SECURITY OFFICE  
 SECURITY BRANCH

POSITION ORGANIZATION CHART

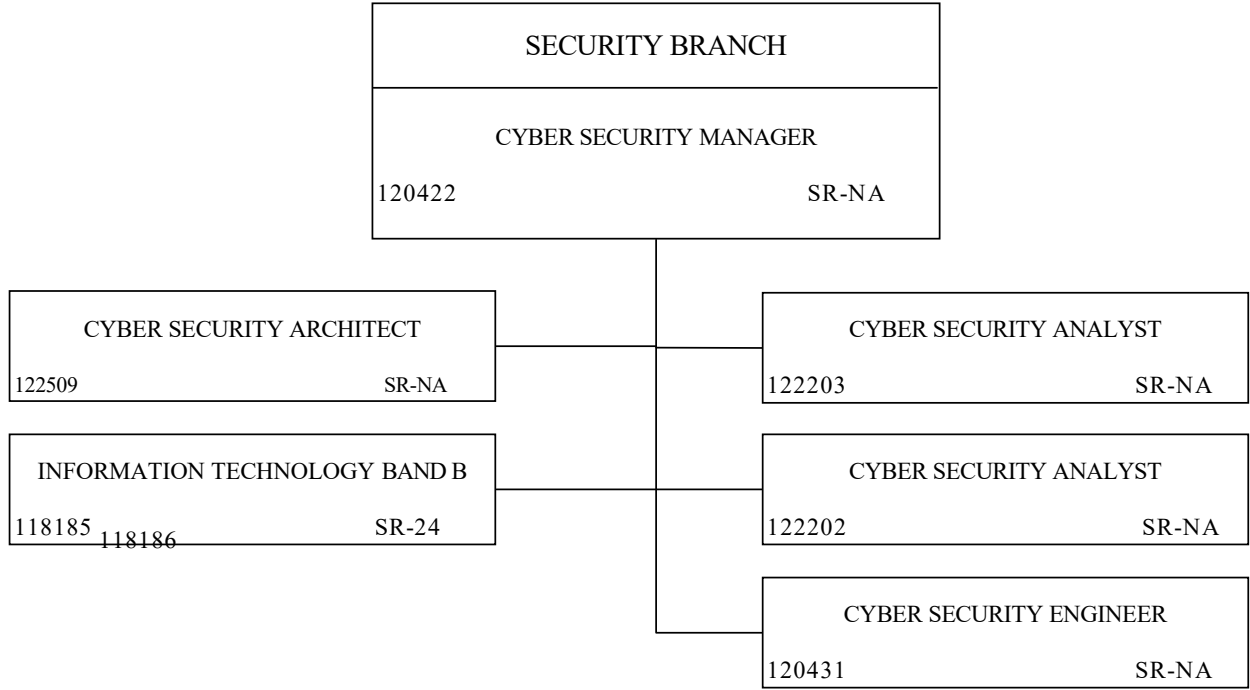

STATE OF HAWAII  
 DEPARTMENT OF ACCOUNTING AND GENERAL SERVICES  
 OFFICE OF ENTERPRISE TECHNOLOGY SERVICES  
 IT GOVERNANCE OFFICE  
 PROGRAM MANAGEMENT BRANCH  
 POSITION ORGANIZATION CHART

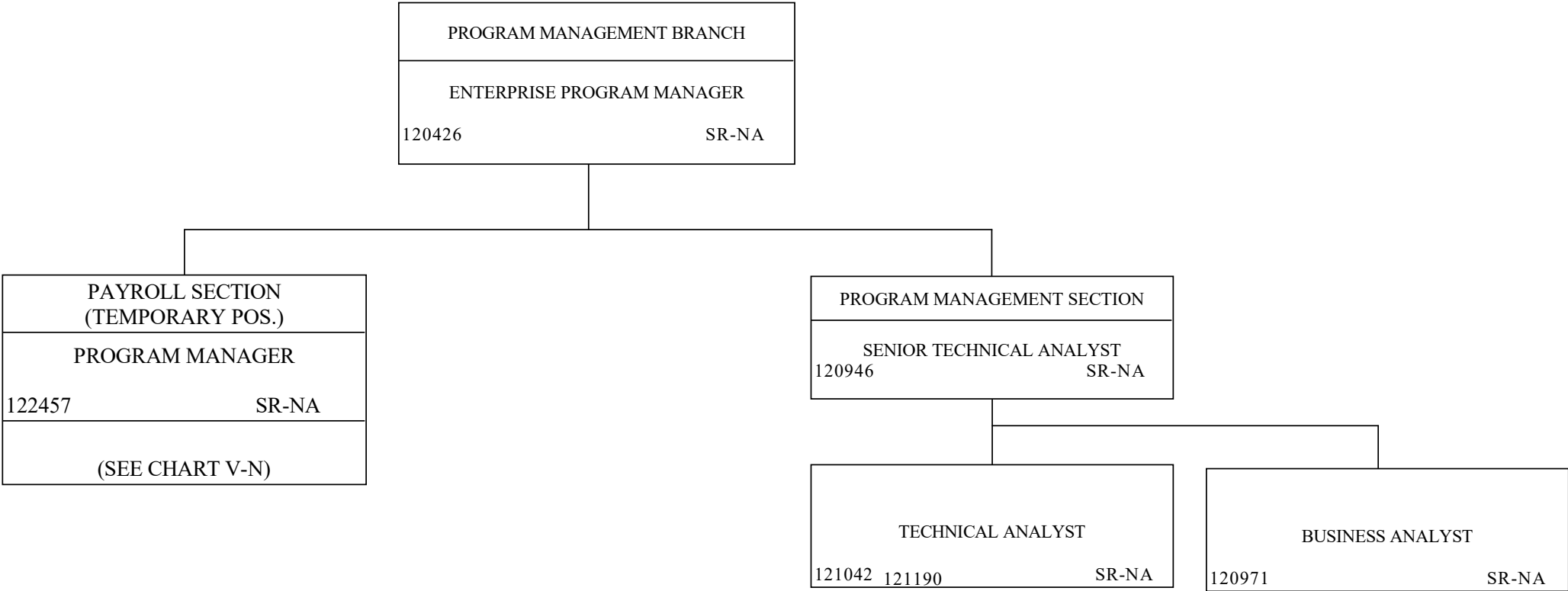

STATE OF HAWAII  
 DEPARTMENT OF ACCOUNTING AND GENERAL SERVICES  
 OFFICE OF ENTERPRISE TECHNOLOGY SERVICES  
 IT GOVERNANCE OFFICE  
 PROGRAM MANAGEMENT BRANCH  
 PAYROLL SECTION

POSITION ORGANIZATION CHART

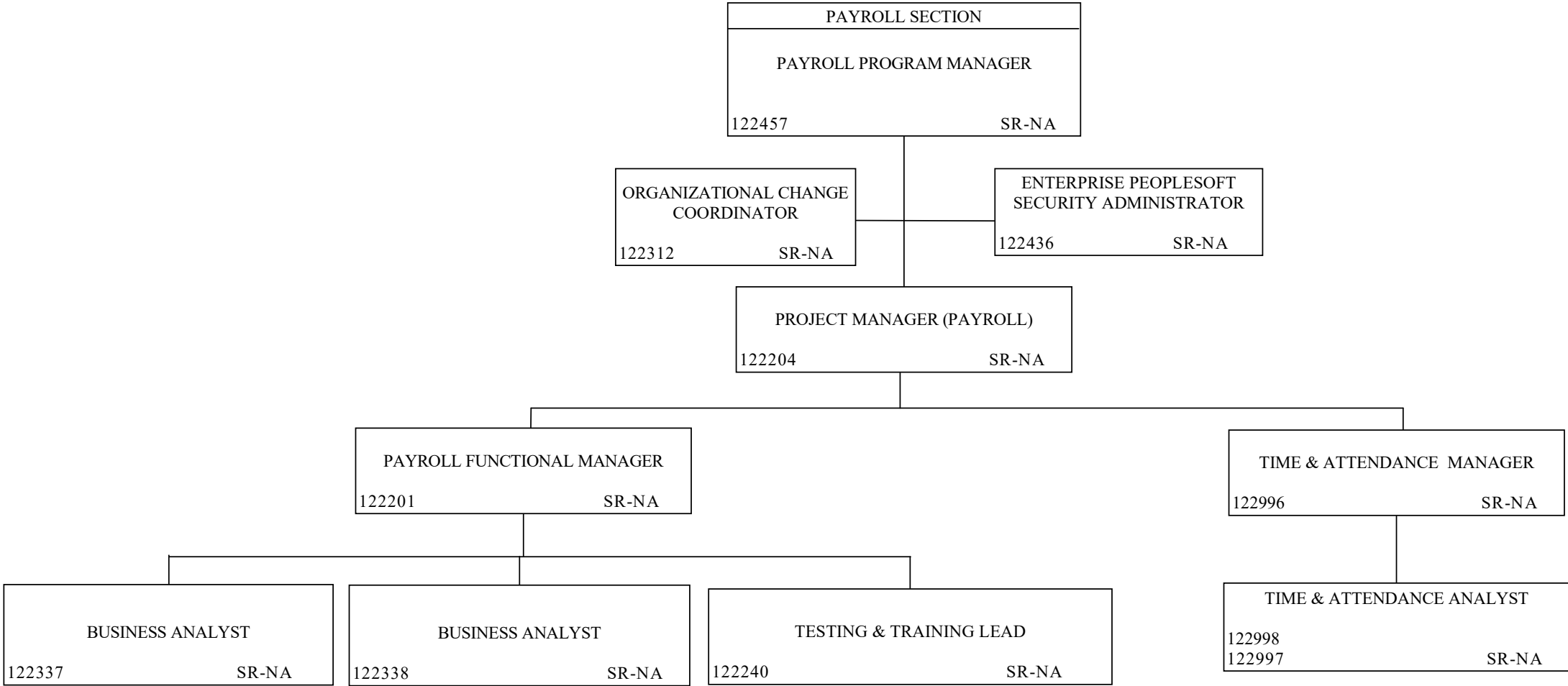

STATE OF HAWAII  
 DEPARTMENT OF ACCOUNTING AND GENERAL SERVICES  
 OFFICE OF ENTERPRISE TECHNOLOGY SERVICES  
 IT GOVERNANCE OFFICE  
 ENTERPRISE ARCHITECT BRANCH

POSITION ORGANIZATION CHART

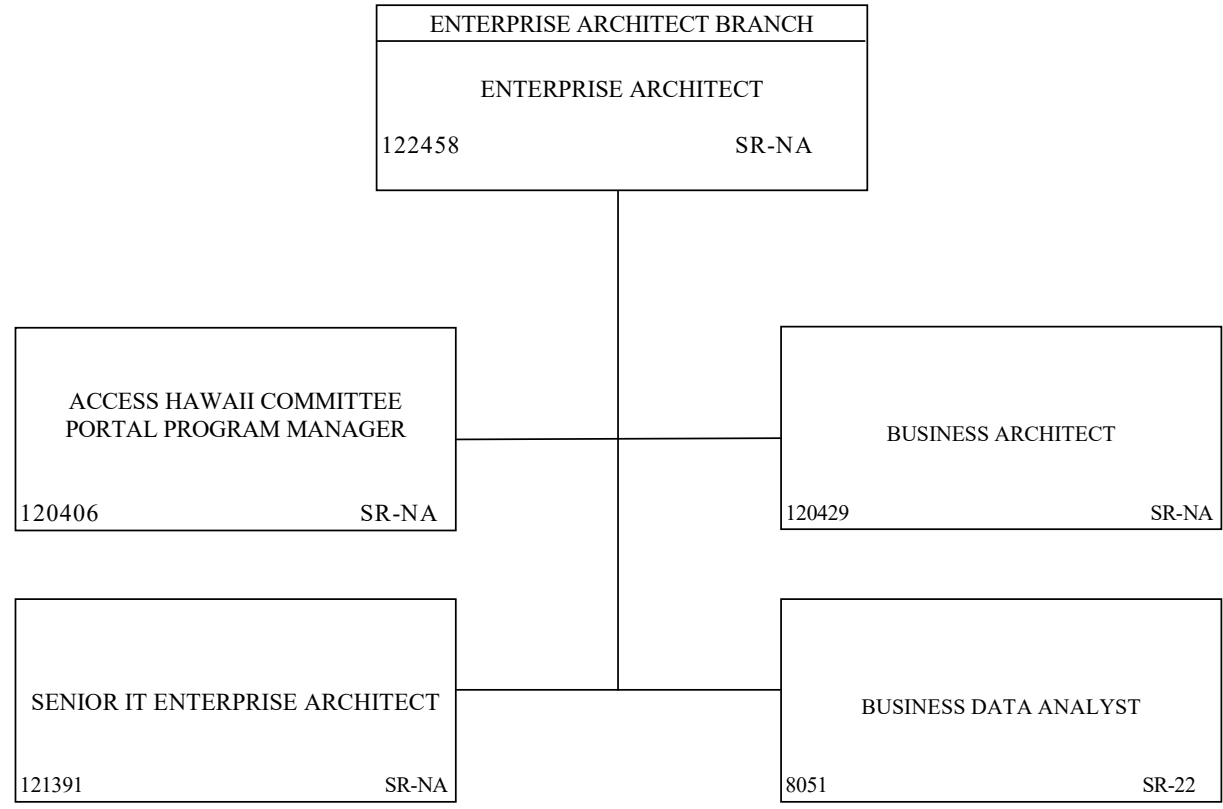

STATE OF HAWAII  
DEPARTMENT OF ACCOUNTING AND GENERAL SERVICES  
CENTRAL SERVICES DIVISION  
ADMINISTRATION

ORGANIZATION CHART

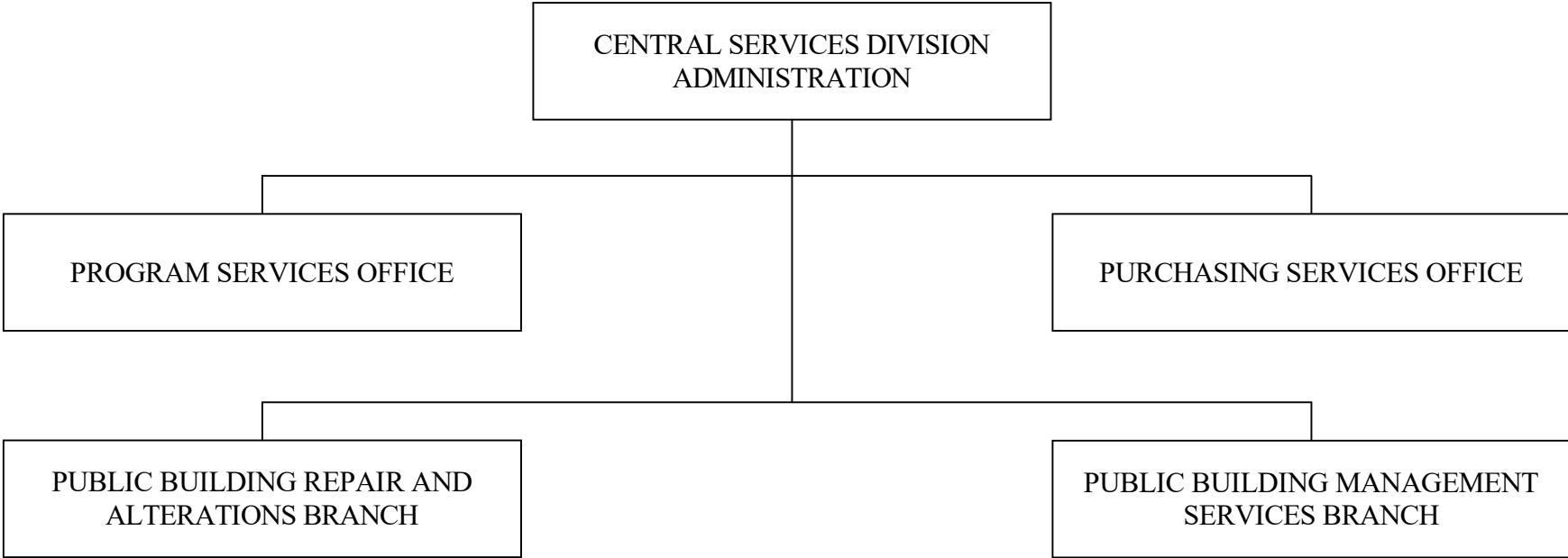



STATE OF HAWAII  
 DEPARTMENT OF ACCOUNTING AND GENERAL SERVICES  
 CENTRAL SERVICES DIVISION

POSITION ORGANIZATION CHART

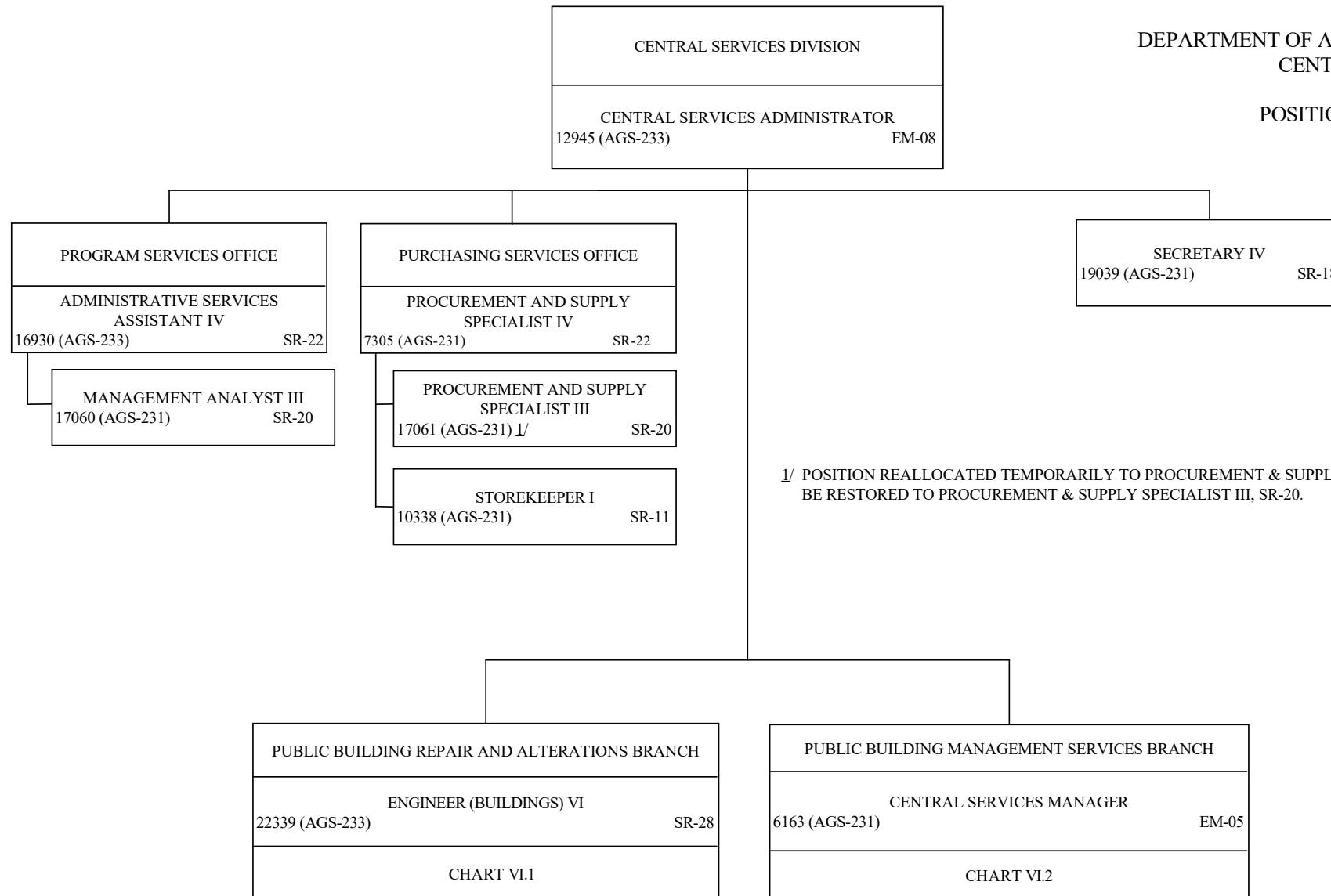

1/ POSITION REALLOCATED TEMPORARILY TO PROCUREMENT & SUPPLY SPECIALIST II, SR-18, EFFECTIVE 2/16/18 AND WILL EVENTUALLY BE RESTORED TO PROCUREMENT & SUPPLY SPECIALIST III, SR-20.

STATE OF HAWAII  
DEPARTMENT OF ACCOUNTING AND GENERAL SERVICES  
CENTRAL SERVICES DIVISION  
PUBLIC BUILDING REPAIR AND ALTERATIONS BRANCH

ORGANIZATION CHART

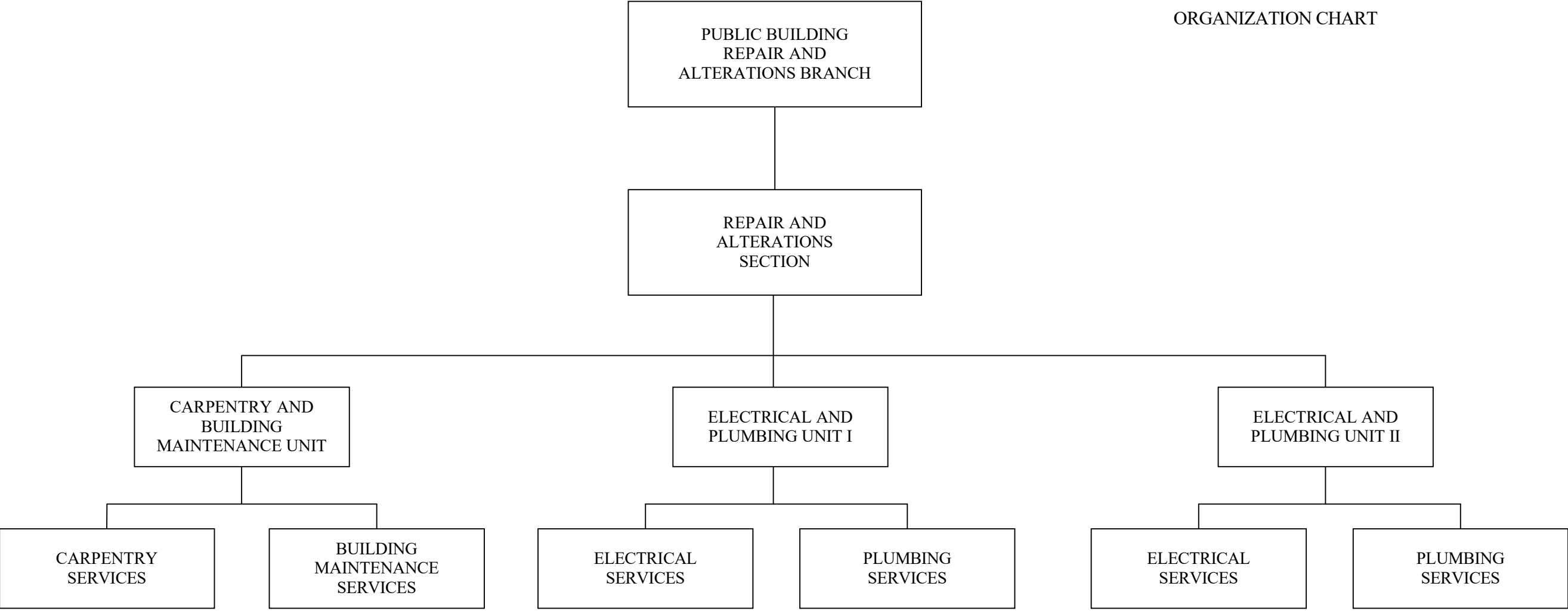

STATE OF HAWAII  
 DEPARTMENT OF ACCOUNTING AND GENERAL SERVICES  
 CENTRAL SERVICES DIVISION  
 PUBLIC BUILDING REPAIR AND ALTERATIONS BRANCH

POSITION ORGANIZATION CHART

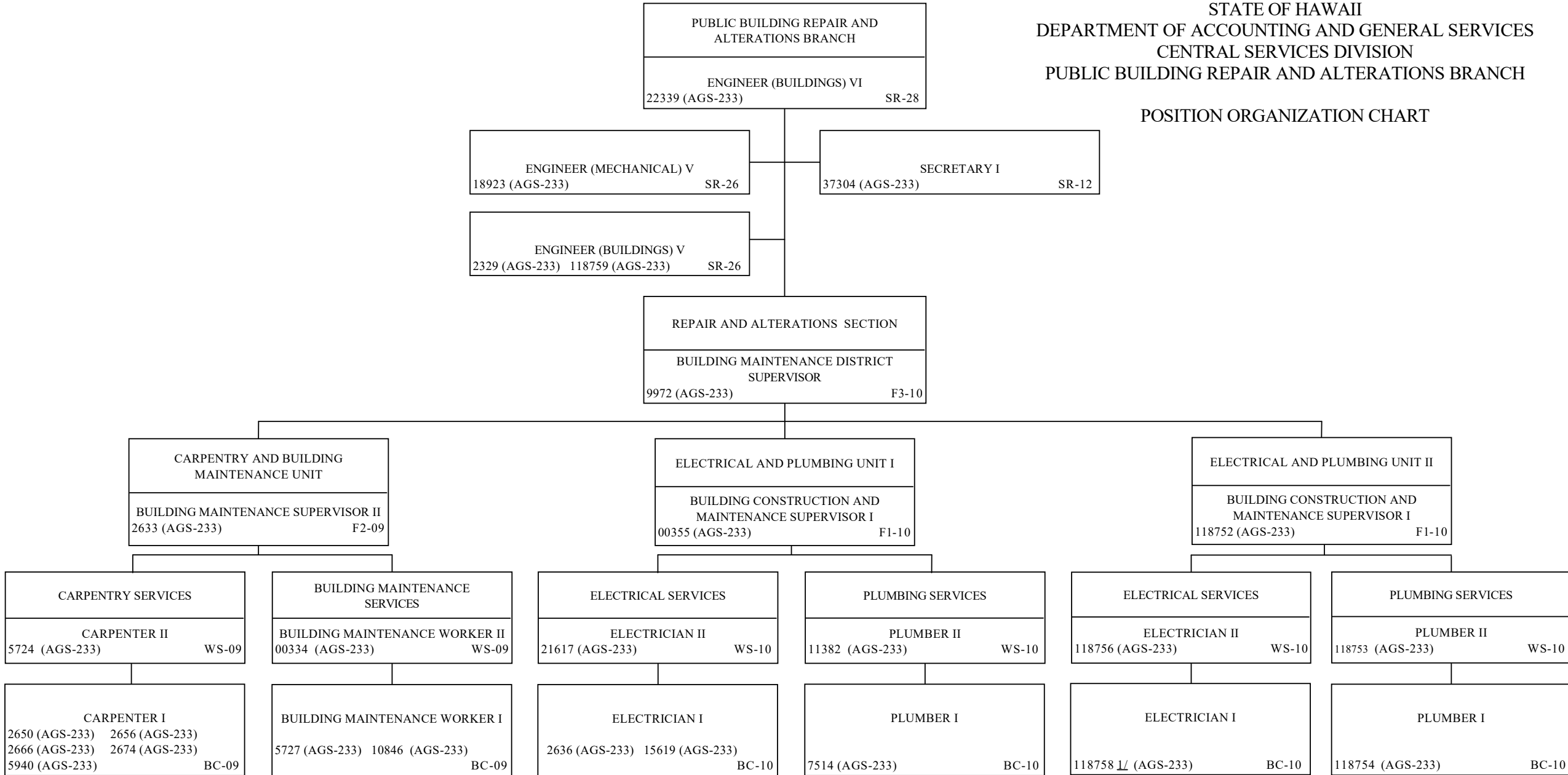

1 POSITION NO. 118758 REALLOCATED TO ELECTRICIAN I, BC-10 FROM ELECTRICIAN HELPER, BC-05, ON AND EFFECTIVE 06/18/18.

STATE OF HAWAII  
 DEPARTMENT OF ACCOUNTING AND GENERAL SERVICES  
 CENTRAL SERVICES DIVISION  
 PUBLIC BUILDING MANAGEMENT SERVICES BRANCH

ORGANIZATION CHART

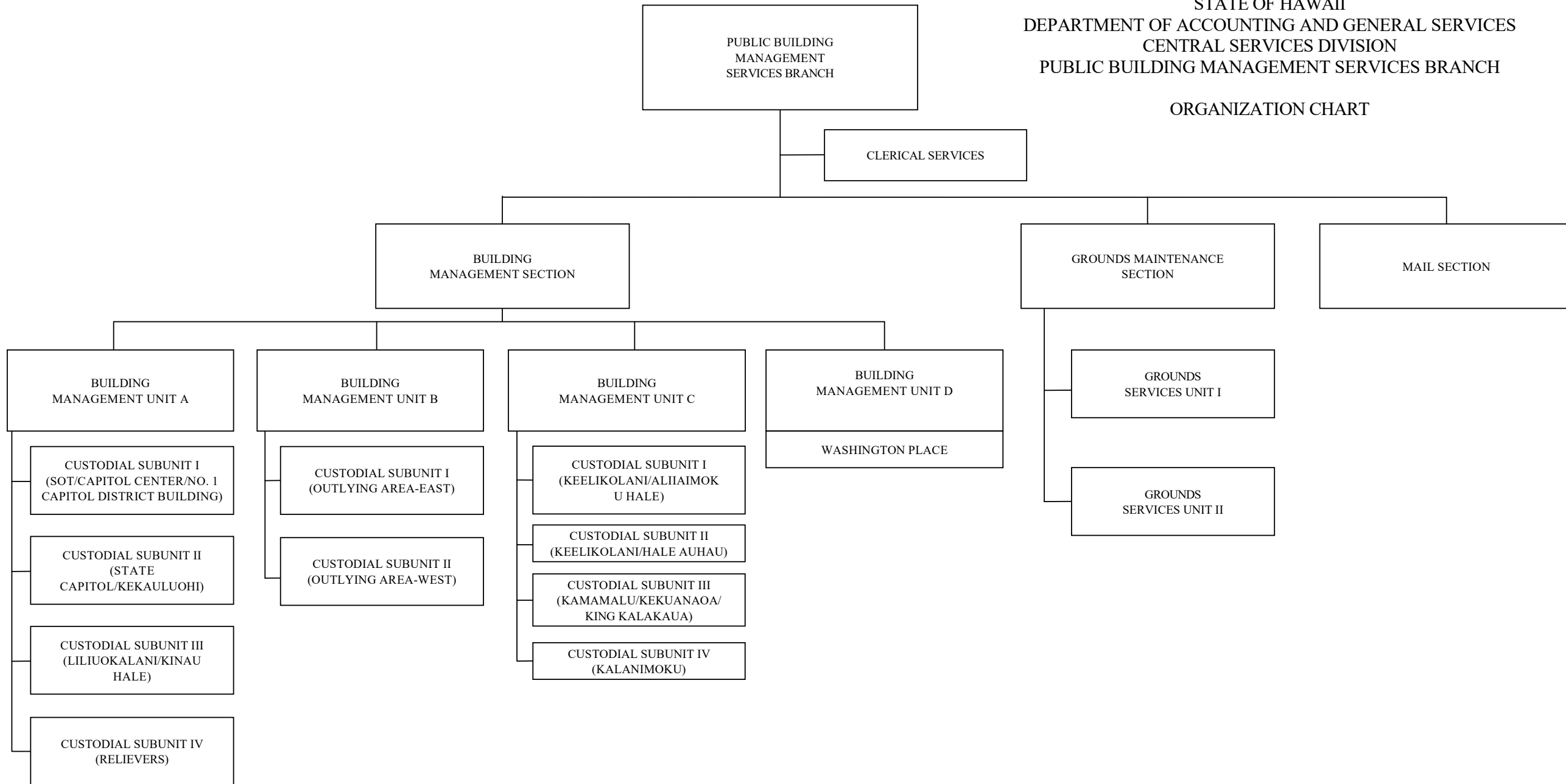

STATE OF HAWAII  
DEPARTMENT OF ACCOUNTING AND GENERAL SERVICES  
CENTRAL SERVICES DIVISION  
PUBLIC BUILDING MANAGEMENT SERVICES BRANCH

POSITION ORGANIZATION CHART

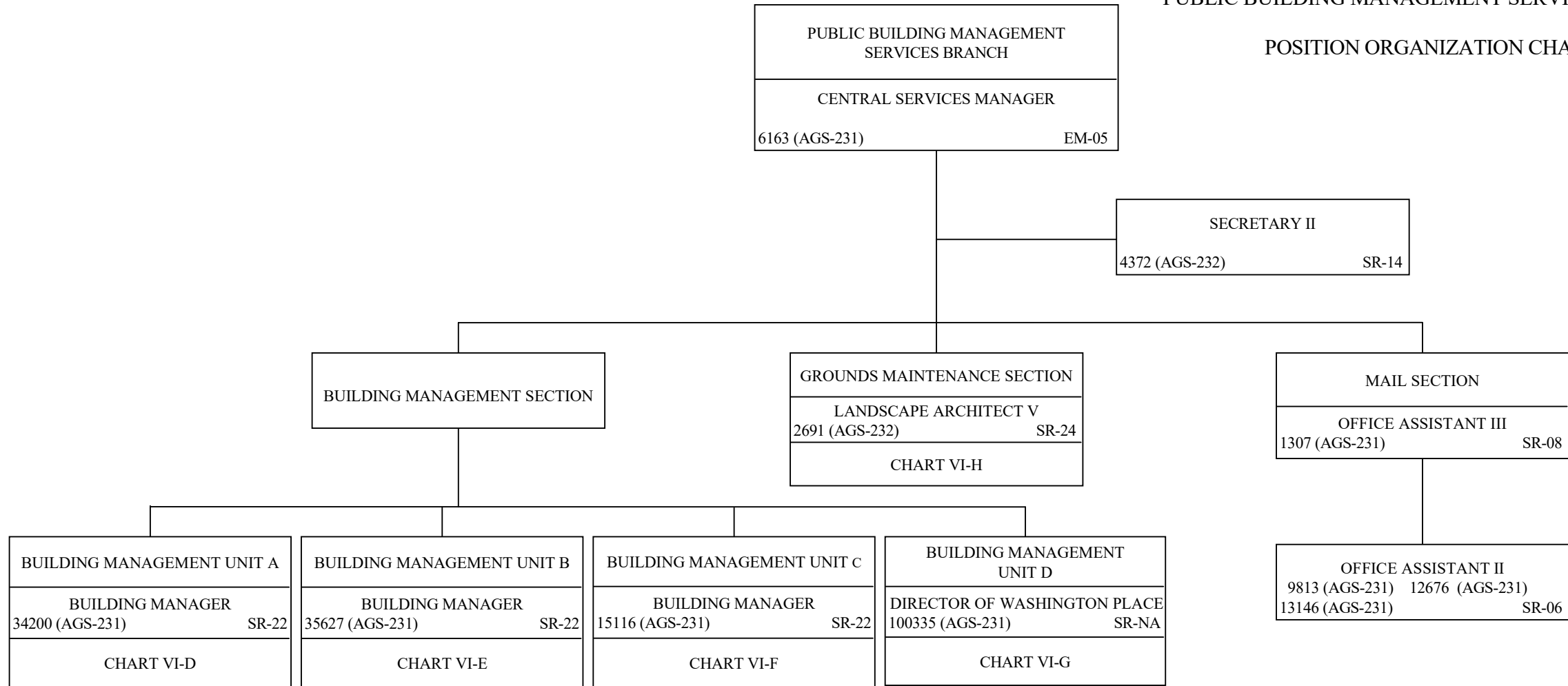

STATE OF HAWAII  
DEPARTMENT OF ACCOUNTING AND GENERAL SERVICES  
CENTRAL SERVICES DIVISION  
PUBLIC BUILDING MANAGEMENT SERVICES BRANCH  
BUILDING MANAGEMENT SECTION  
BUILDING MANAGEMENT UNIT A

POSITION ORGANIZATION CHART

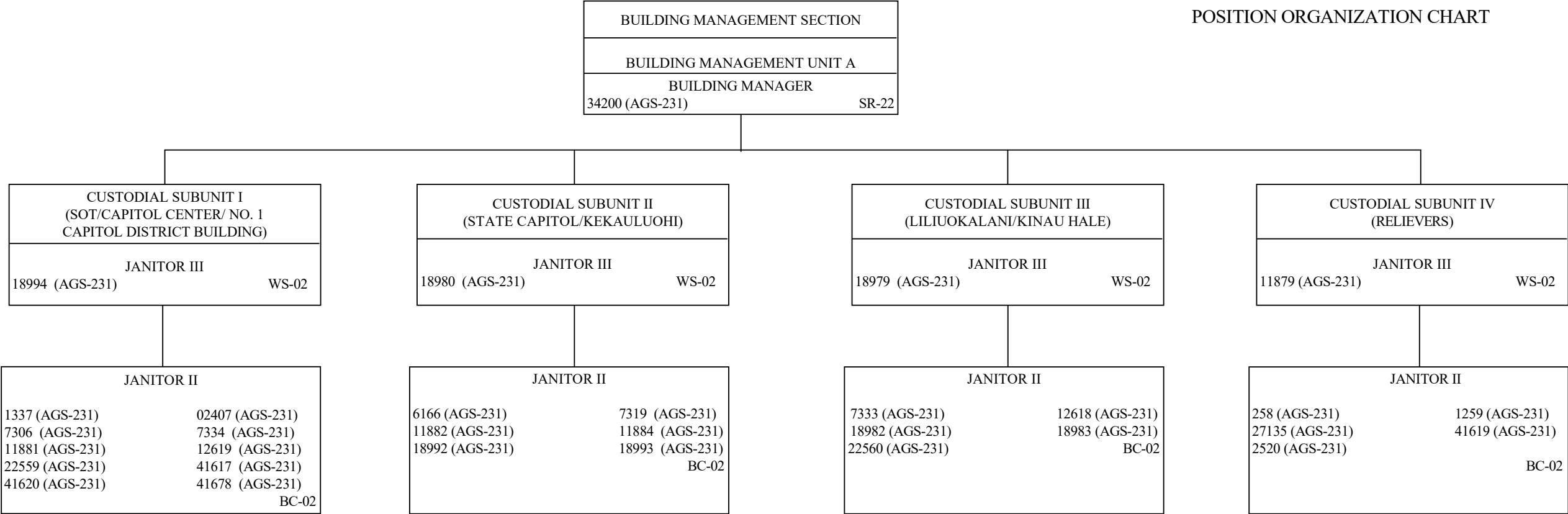

STATE OF HAWAII  
DEPARTMENT OF ACCOUNTING AND GENERAL SERVICES  
CENTRAL SERVICES DIVISION  
PUBLIC BUILDING MANAGEMENT SERVICES BRANCH  
BUILDING MANAGEMENT SECTION  
BUILDING MANAGEMENT UNIT B  
POSITION ORGANIZATION CHART

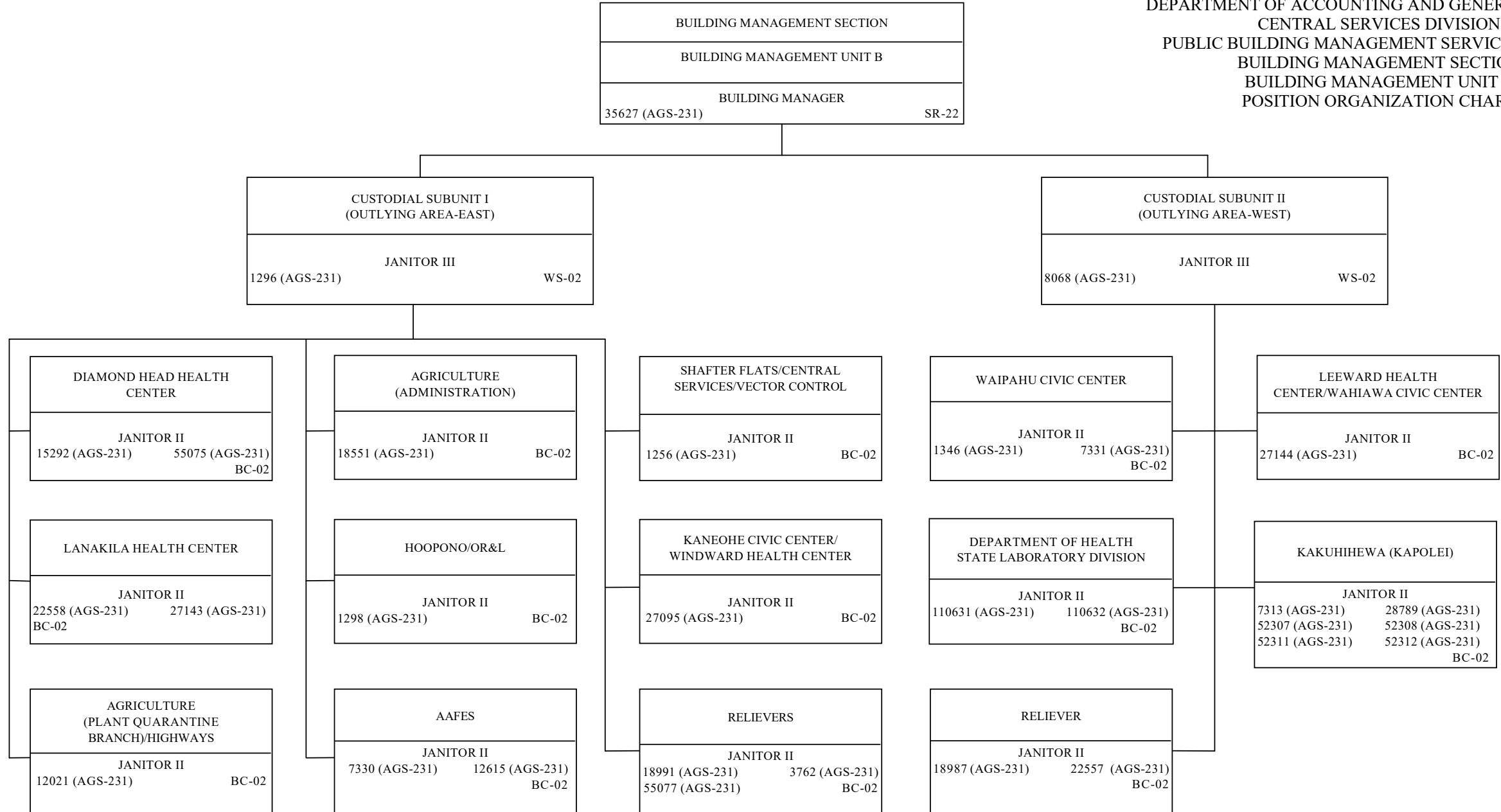

STATE OF HAWAII  
DEPARTMENT OF ACCOUNTING AND GENERAL SERVICES  
CENTRAL SERVICES DIVISION  
PUBLIC BUILDING MANAGEMENT SERVICES BRANCH  
BUILDING MANAGEMENT SECTION  
BUILDING MANAGEMENT UNIT C  
  
POSITION ORGANIZATION CHART

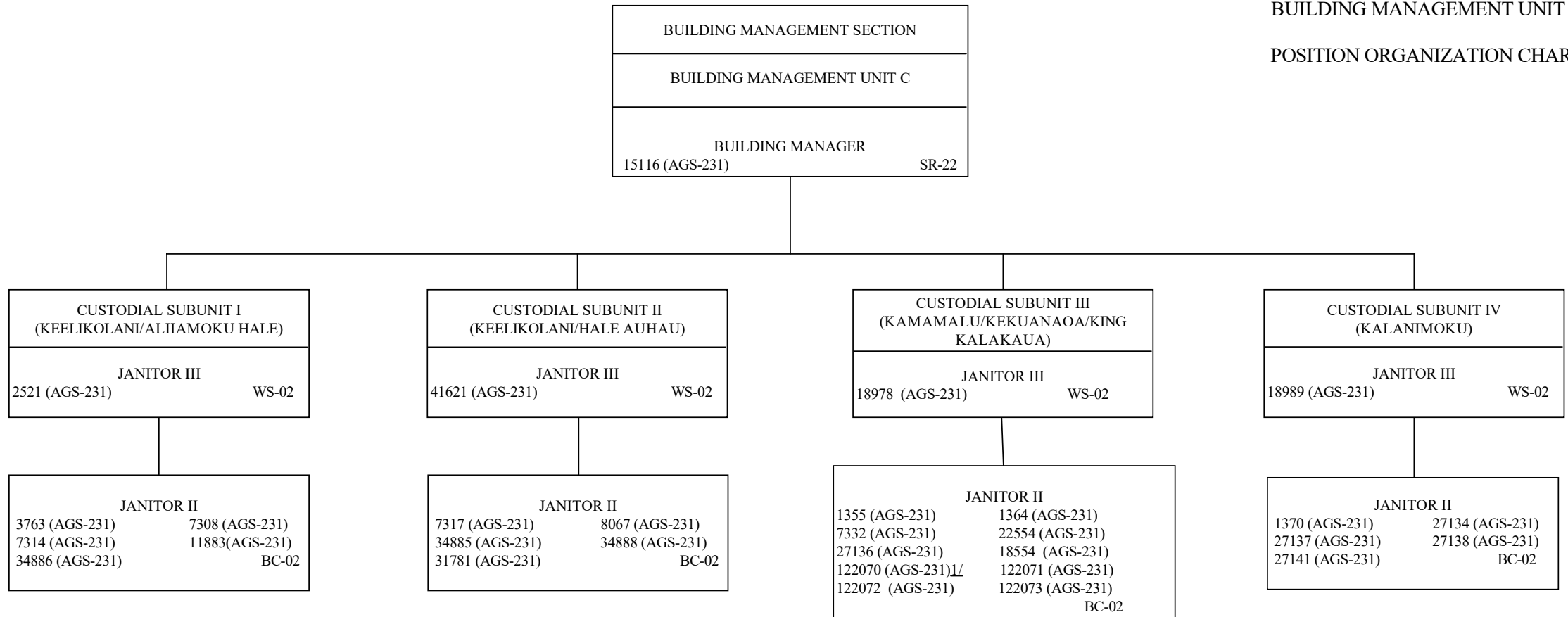

1/ POSITION NO. 122070 REALLOCATED TO JANITOR II, BC-02, ON AND EFFECTIVE 12/01/16.



STATE OF HAWAII  
DEPARTMENT OF ACCOUNTING AND GENERAL SERVICES  
CENTRAL SERVICES DIVISION  
PUBLIC BUILDING MANAGEMENT SERVICES BRANCH  
BUILDING MANAGEMENT SECTION  
BUILDING MANAGEMENT UNIT D

POSITION ORGANIZATION CHART

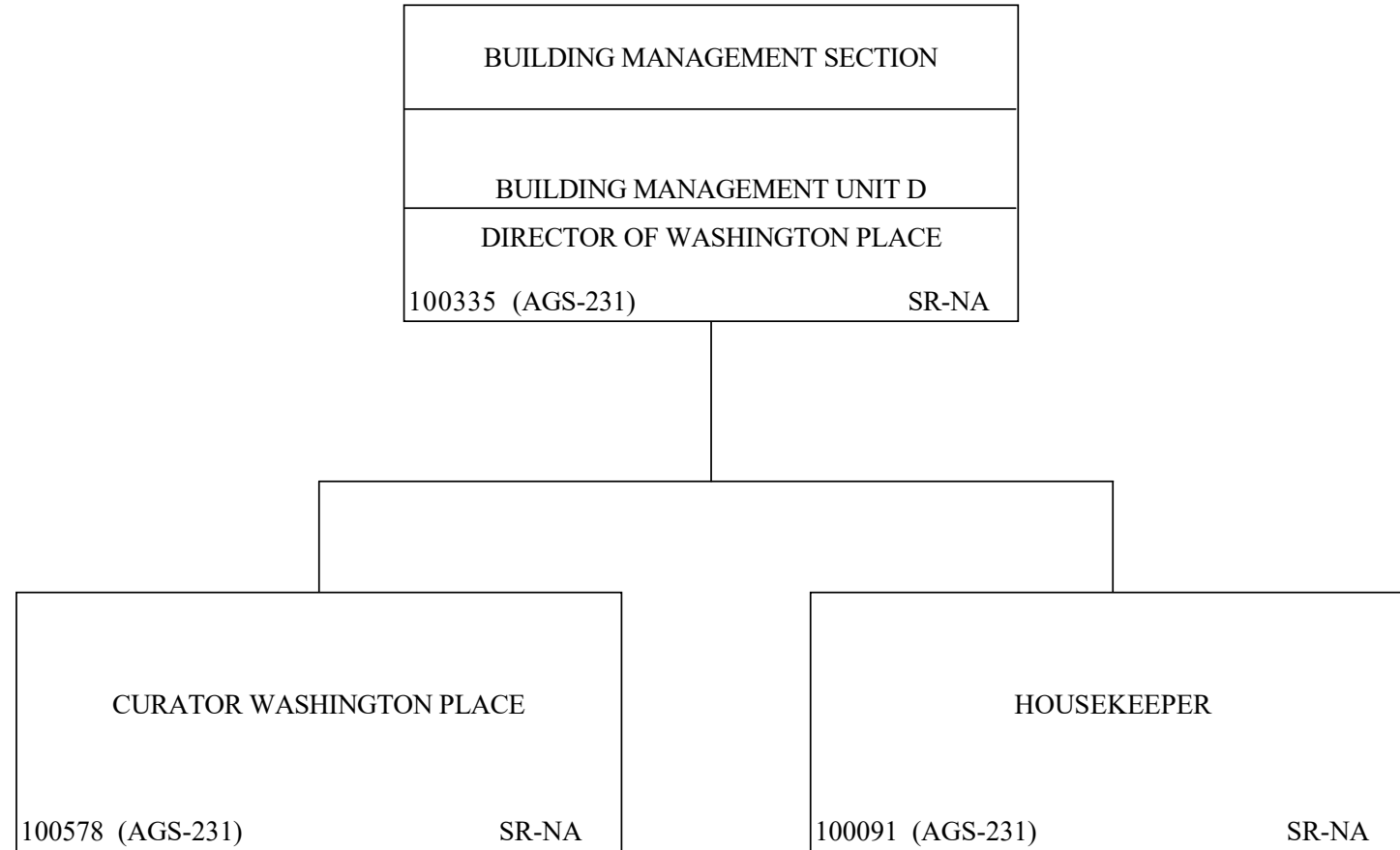

STATE OF HAWAII  
DEPARTMENT OF ACCOUNTING AND GENERAL SERVICES  
CENTRAL SERVICES DIVISION  
PUBLIC BUILDING MANAGEMENT SERVICES BRANCH  
**GROUNDS MAINTENANCE SECTION**

POSITION ORGANIZATION CHART

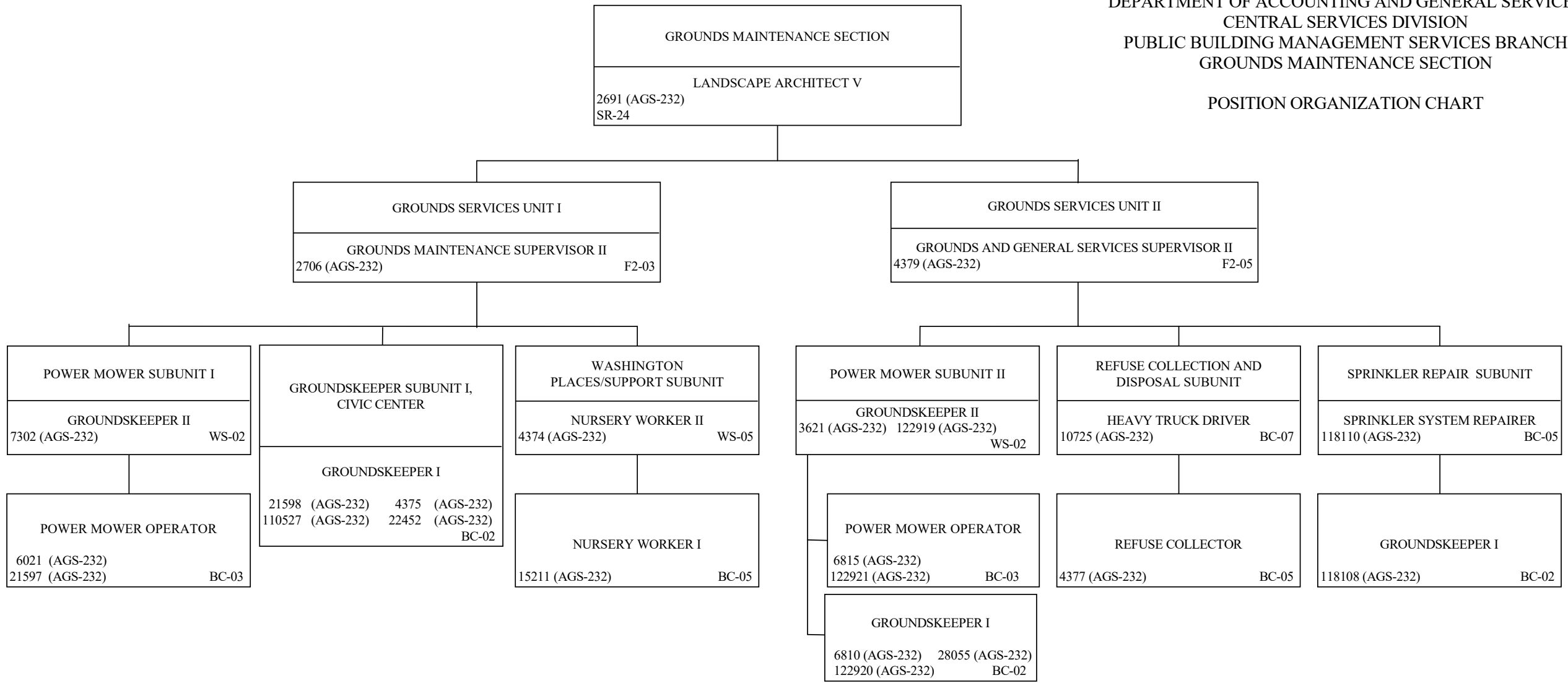

STATE OF HAWAII  
DEPARTMENT OF ACCOUNTING AND GENERAL SERVICES  
PUBLIC WORKS DIVISION

ORGANIZATION CHART

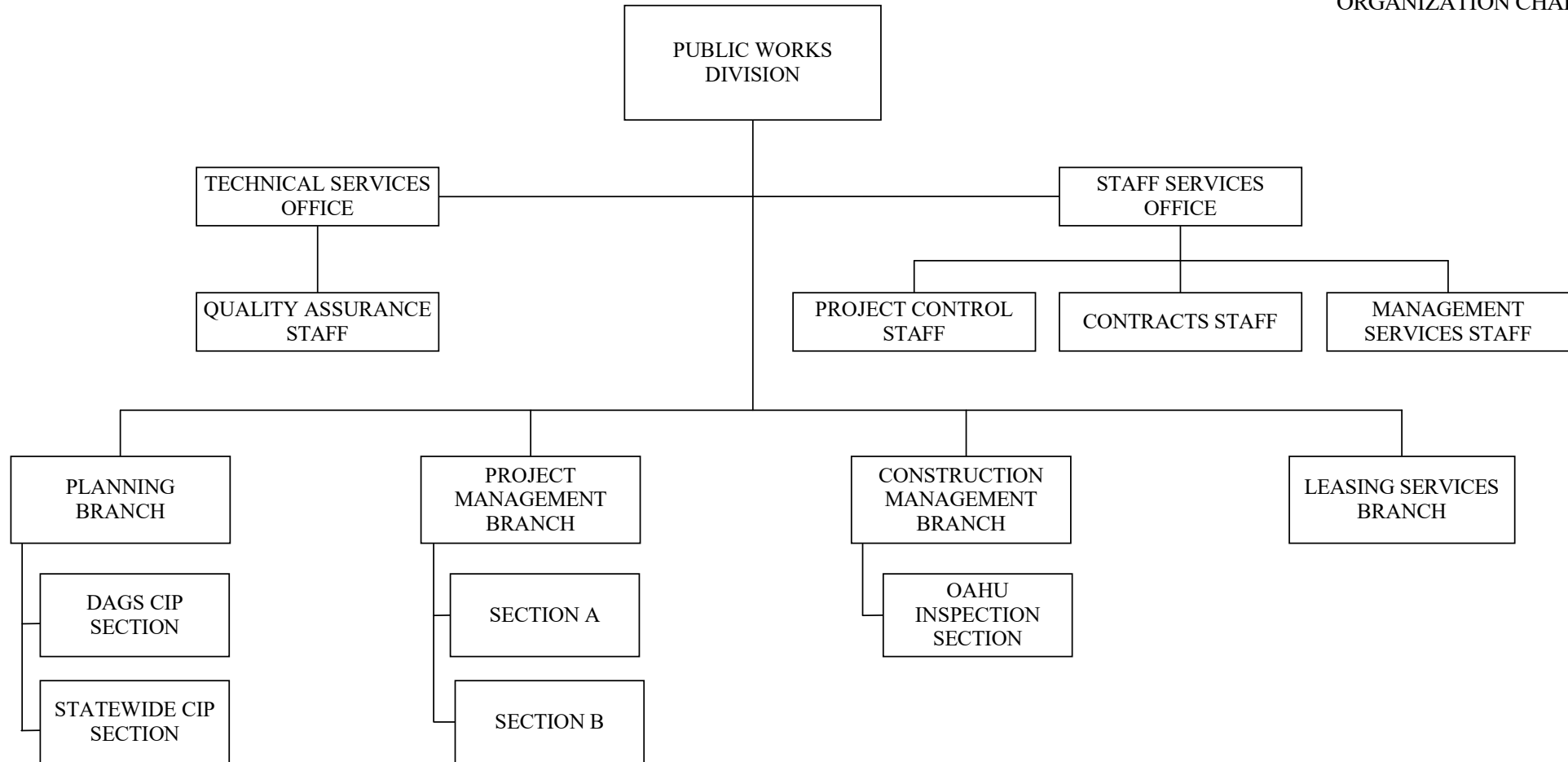

STATE OF HAWAII  
 DEPARTMENT OF ACCOUNTING AND GENERAL SERVICES  
 PUBLIC WORKS DIVISION

POSITION ORGANIZATION CHART

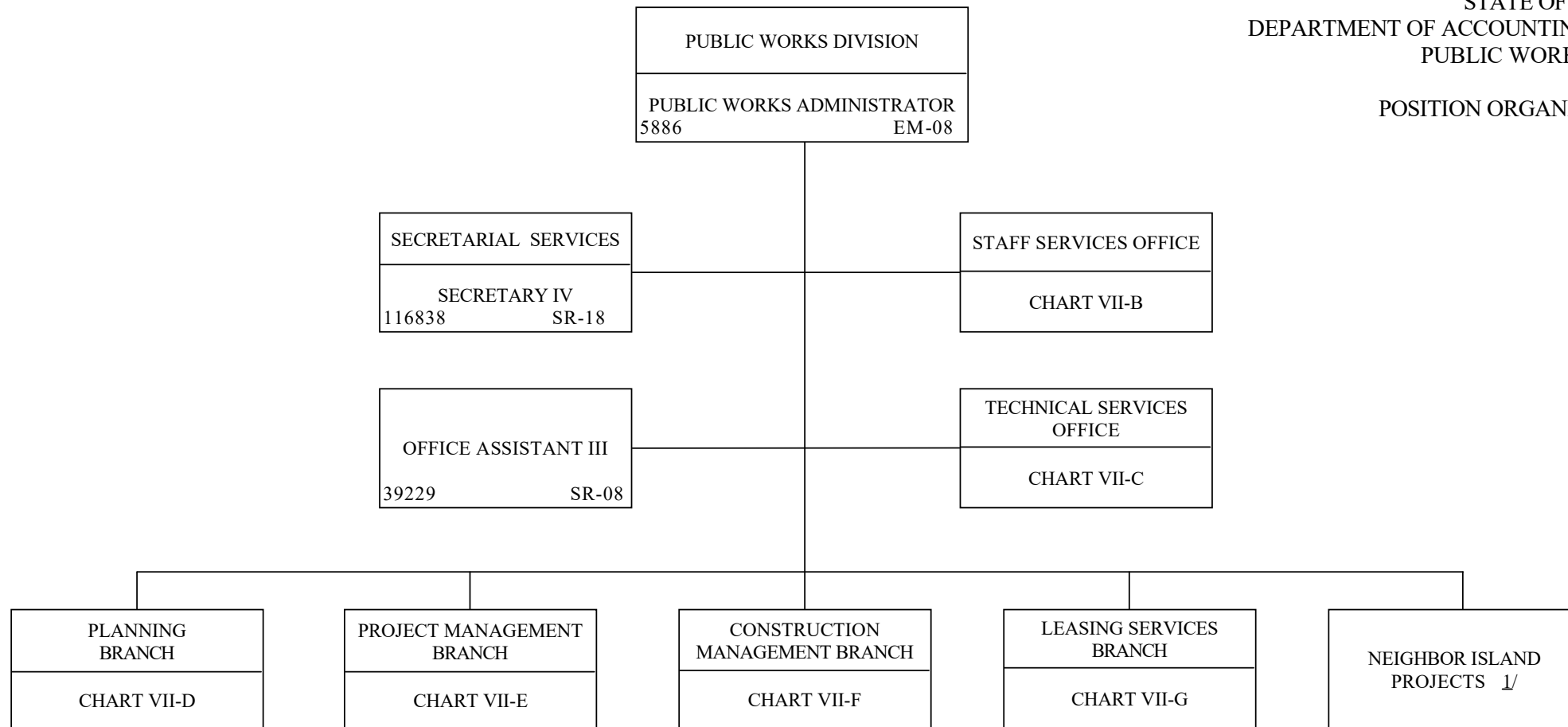

1/ 7 POSITIONS SUPERVISED BY MAUI DISTRICT ENGINEER, DAGS.  
 11 POSITIONS SUPERVISED BY HAWAII DISTRICT PUBLIC WORKS MANAGER, DAGS  
 4 POSITIONS SUPERVISED BY KAUAI DISTRICT ENGINEER, DAGS.

STATE OF HAWAII  
 DEPARTMENT OF ACCOUNTING AND GENERAL SERVICES  
 PUBLIC WORKS DIVISION  
 STAFF SERVICES OFFICE

POSITION ORGANIZATION CHART

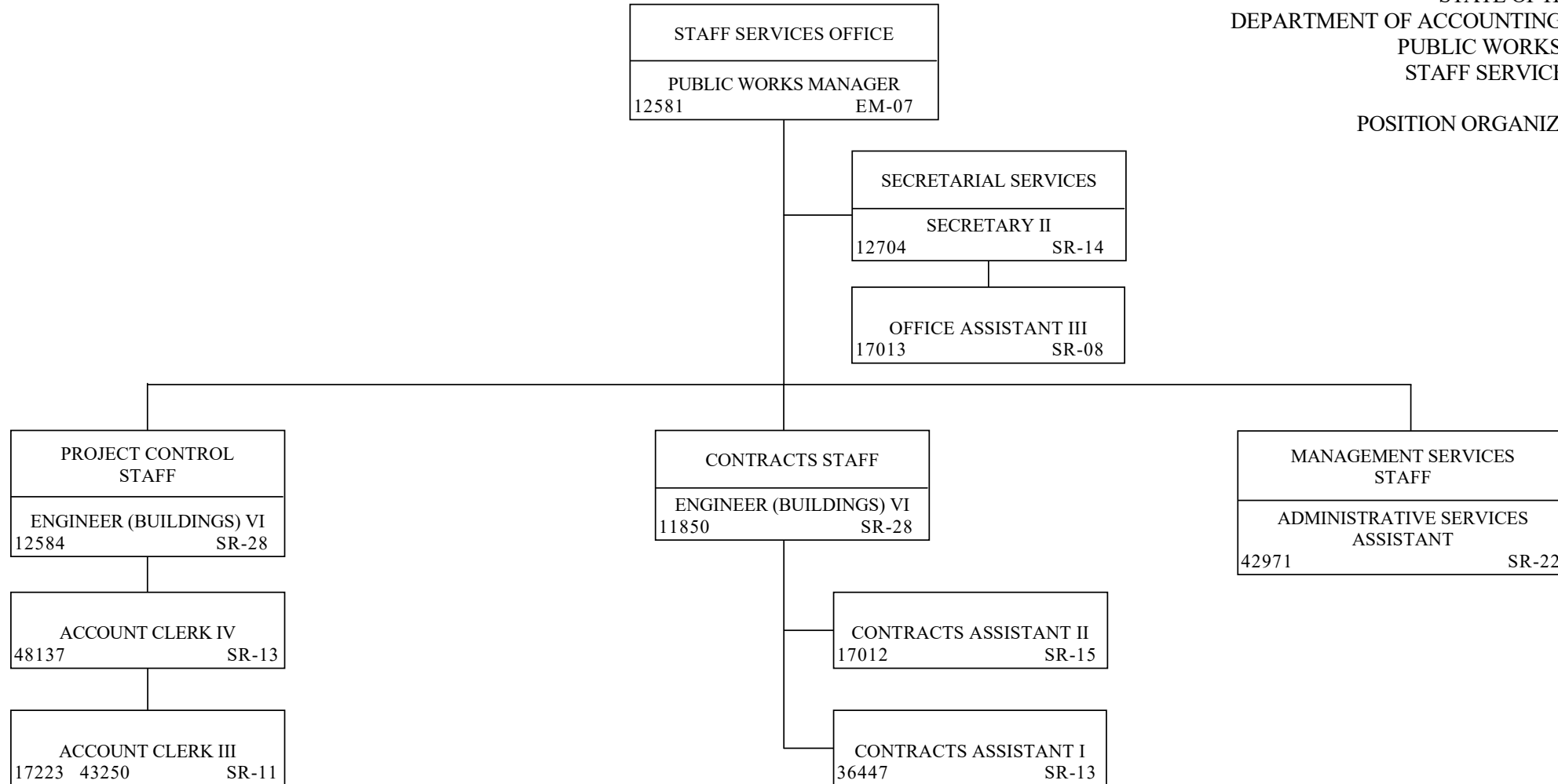

STATE OF HAWAII  
 DEPARTMENT OF ACCOUNTING AND GENERAL SERVICES  
 PUBLIC WORKS DIVISION  
 TECHNICAL SERVICES OFFICE

POSITION ORGANIZATION CHART

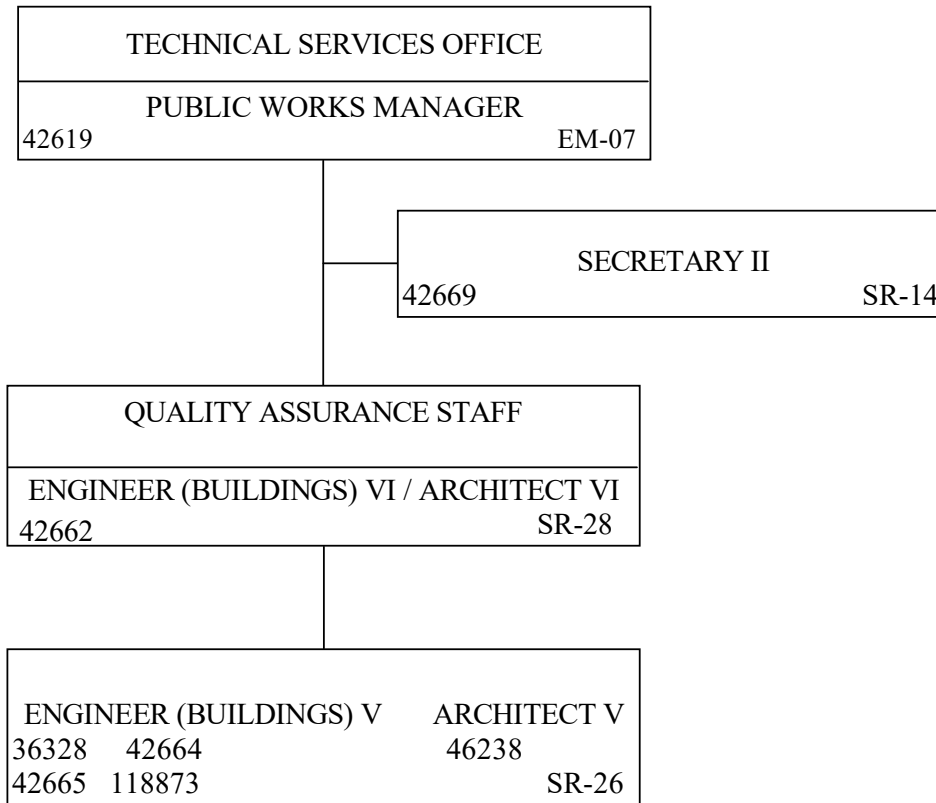

STATE OF HAWAII  
DEPARTMENT OF ACCOUNTING AND GENERAL SERVICES  
PUBLIC WORKS DIVISION  
PLANNING BRANCH

POSITION ORGANIZATION CHART

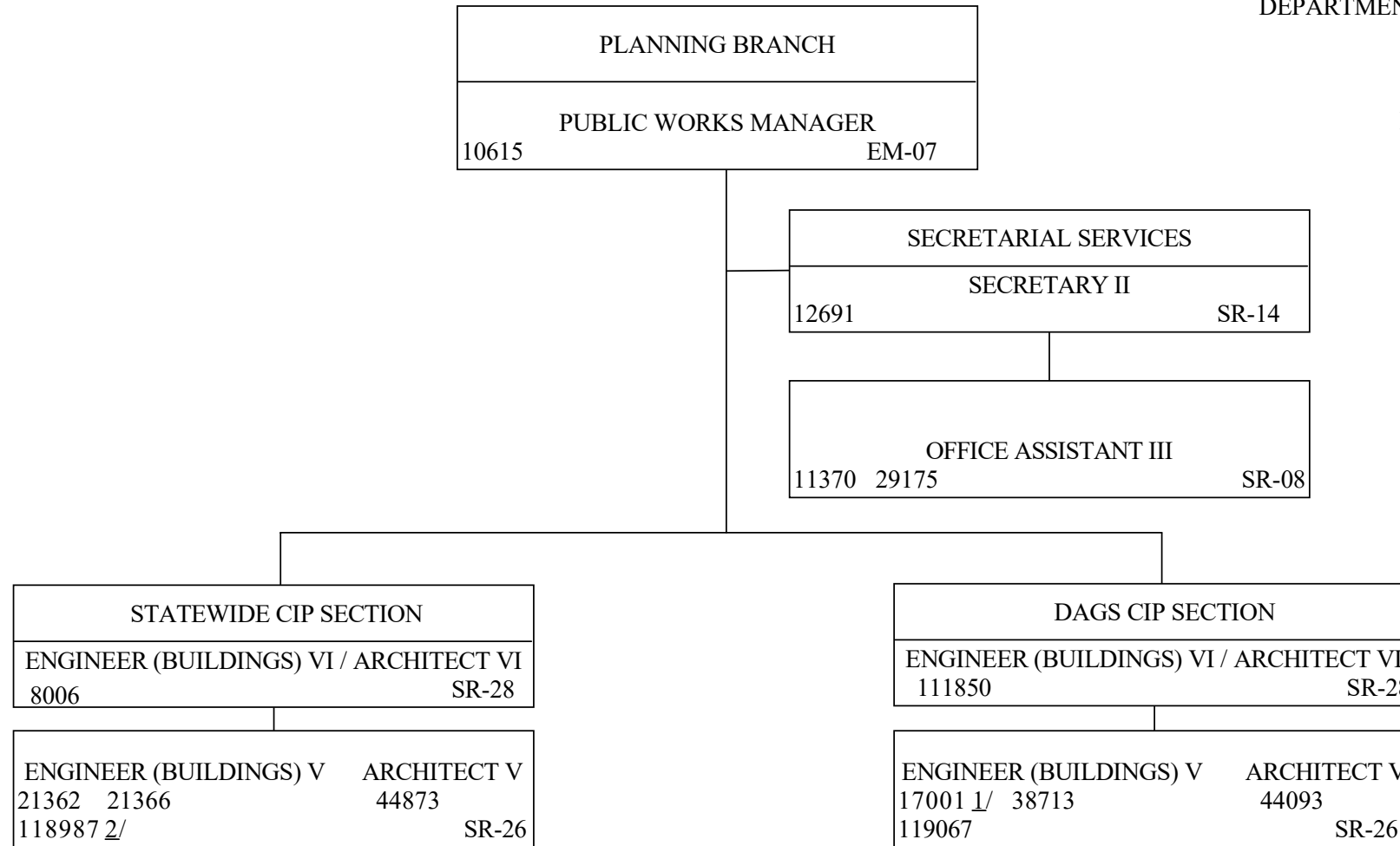

1/ POSITION NO. 17001 REALLOCATED TEMPORARILY TO ENGINEER (BUILDINGS) III, SR-22, ON 09/09/05, EFFECTIVE 09/16/05.

2/ POSITION NO. 118987 REALLOCATED TEMPORARILY TO ENGINEER II, SR-20, ON 03/24/17, EFFECTIVE 04/01/17. WILL EVENTUALLY BE RESTORED TO ENGINEER (BUILDINGS) V, SR-26.

STATE OF HAWAII  
DEPARTMENT OF ACCOUNTING AND GENERAL SERVICES  
PUBLIC WORKS DIVISION  
PROJECT MANAGEMENT BRANCH  
POSITION ORGANIZATION CHART

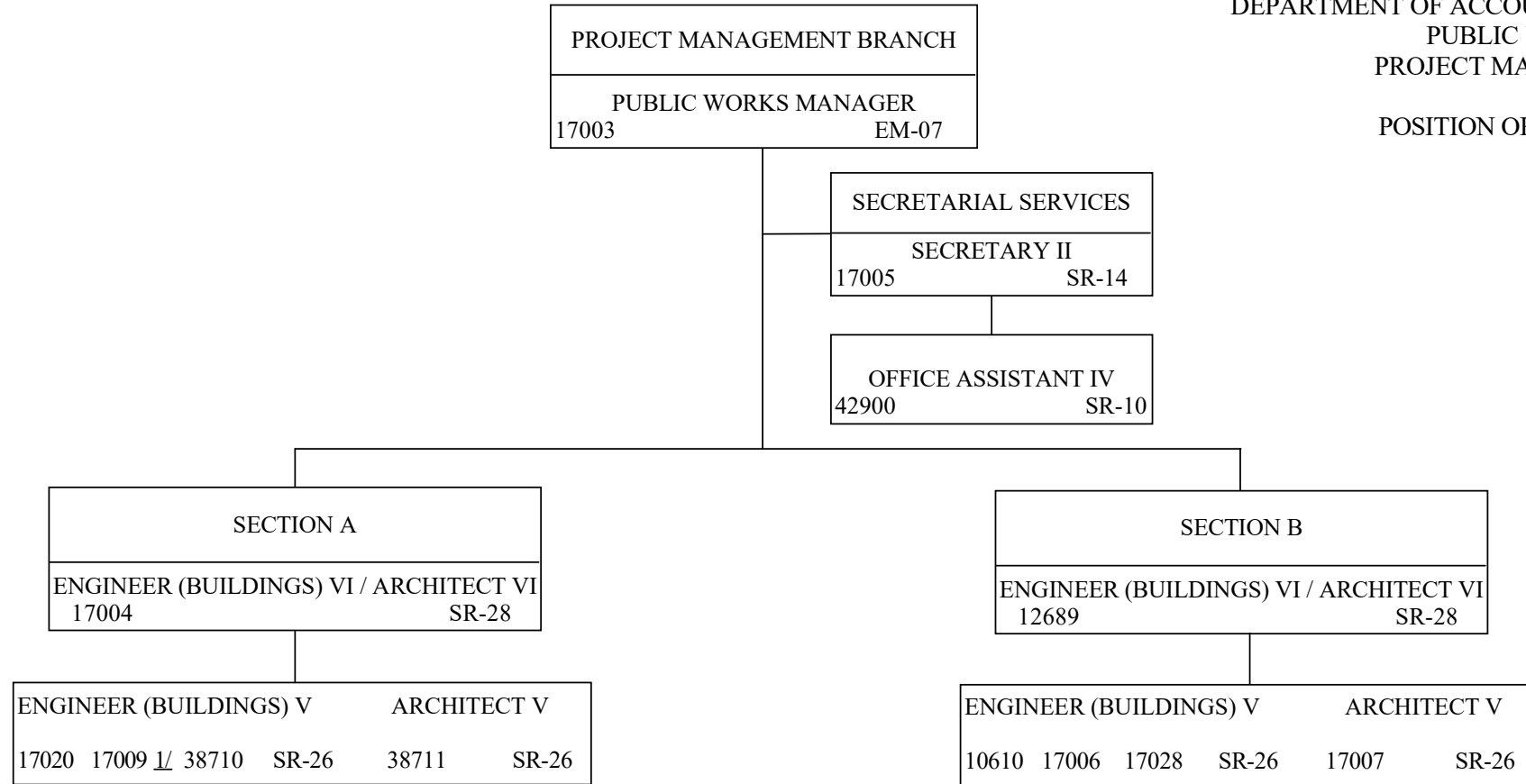

1 POSITION NO. 17009 REALLOCATED TEMPORARILY FROM ENGINEER (BUILDINGS) IV, SR-24, BACK TO AUTHORIZED ENGINEER (BUILDINGS) V, SR-26, EFFECTIVE 01/16/20.



STATE OF HAWAII  
DEPARTMENT OF ACCOUNTING AND GENERAL SERVICES  
PUBLIC WORKS DIVISION  
CONSTRUCTION MANAGEMENT BRANCH

POSITION ORGANIZATION CHART

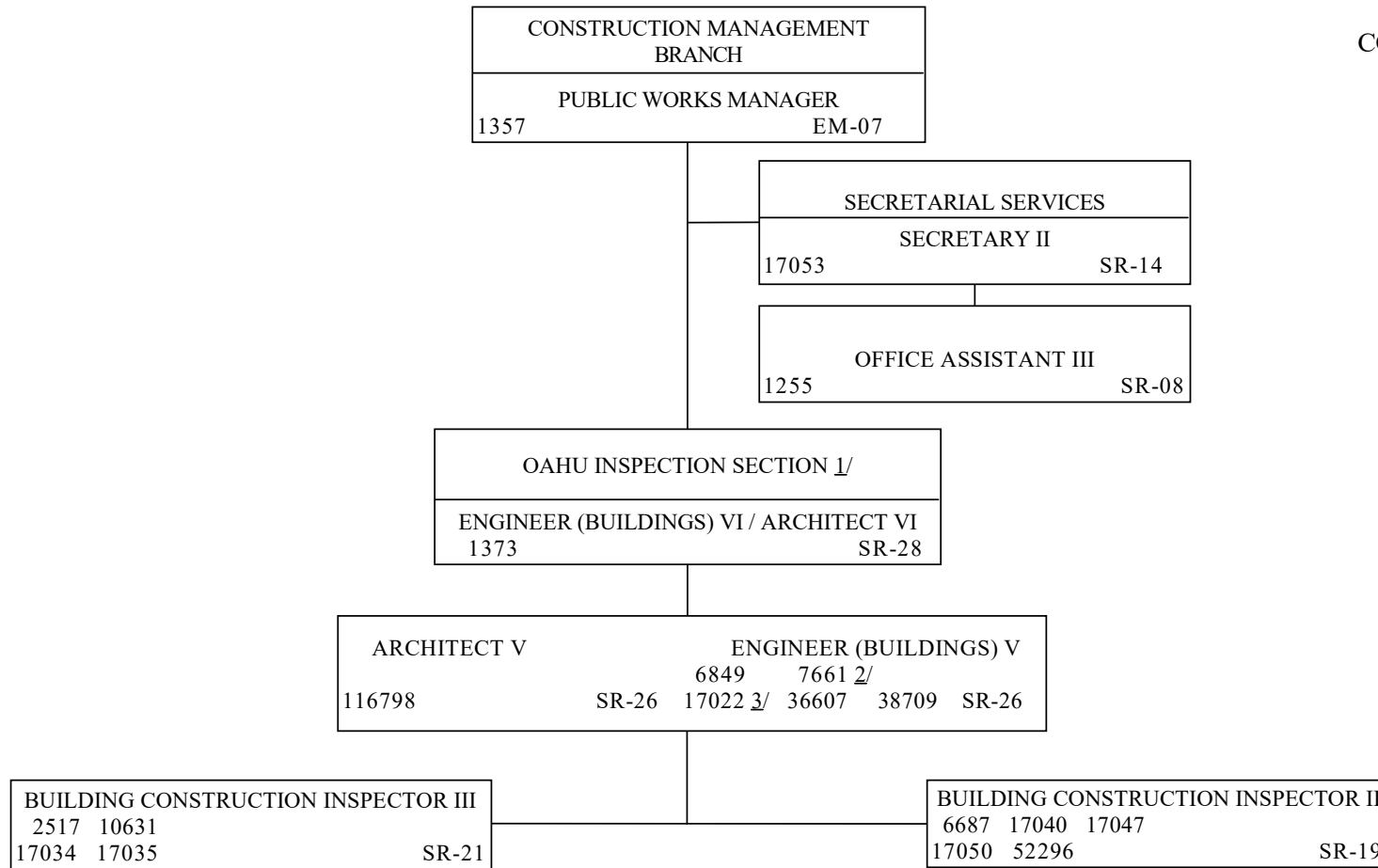

1/ SUPERVISION IS PROVIDED BY ARCHITECT AND ENGINEERS OVER INSPECTORS ON A PROJECT AND AREA BASIS.

2/ POSITION NO. 7661 REALLOCATED TEMPORARILY TO ENGINEER (BUILDINGS) III, SR-22 ON 09/18/02, EFFECTIVE 01/01/02, AND WILL EVENTUALLY BE RESTORED TO ENGINEER (BUILDINGS) V, SR-26.

3/ POSITION NO. 17022 REALLOCATED TEMPORARILY TO ENGINEER (BUILDINGS) III, SR-22 ON AND EFFECTIVE 10/01/13 AND WILL EVENTUALLY BE RESTORED TO ENGINEER (BUILDINGS) V, SR-26.

STATE OF HAWAII  
DEPARTMENT OF ACCOUNTING AND GENERAL SERVICES  
PUBLIC WORKS DIVISION  
LEASING SERVICES BRANCH

POSITION ORGANIZATION CHART

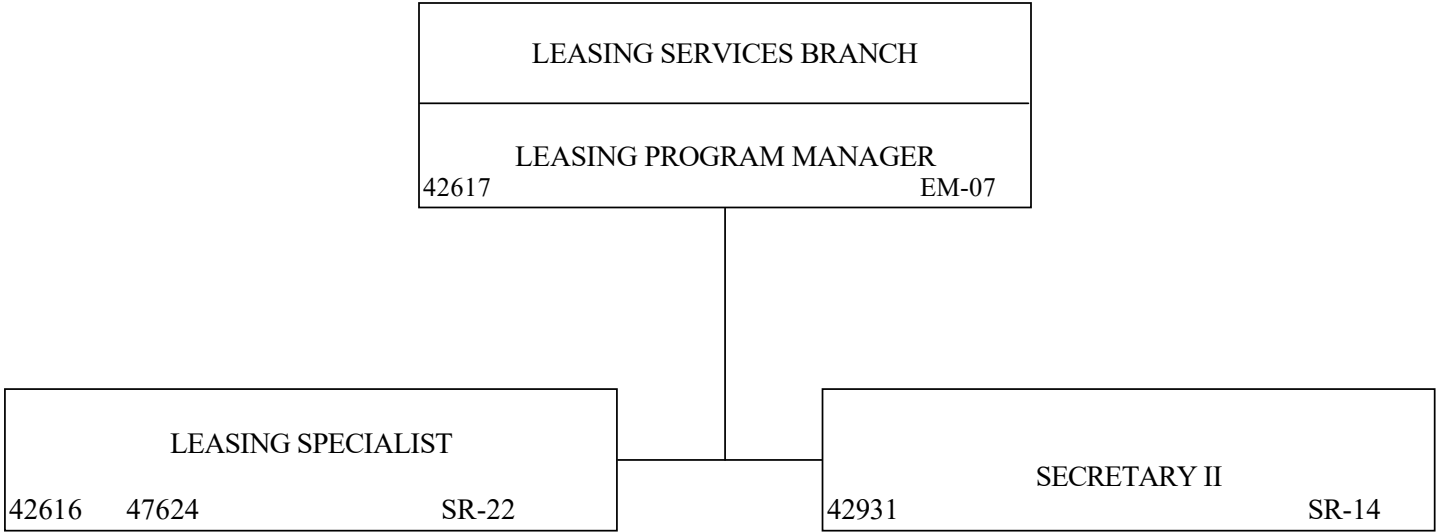

STATE OF HAWAII  
DEPARTMENT OF ACCOUNTING AND GENERAL SERVICES  
DEPARTMENT ADMINISTRATION  
ARCHIVES DIVISION

ORGANIZATION CHART

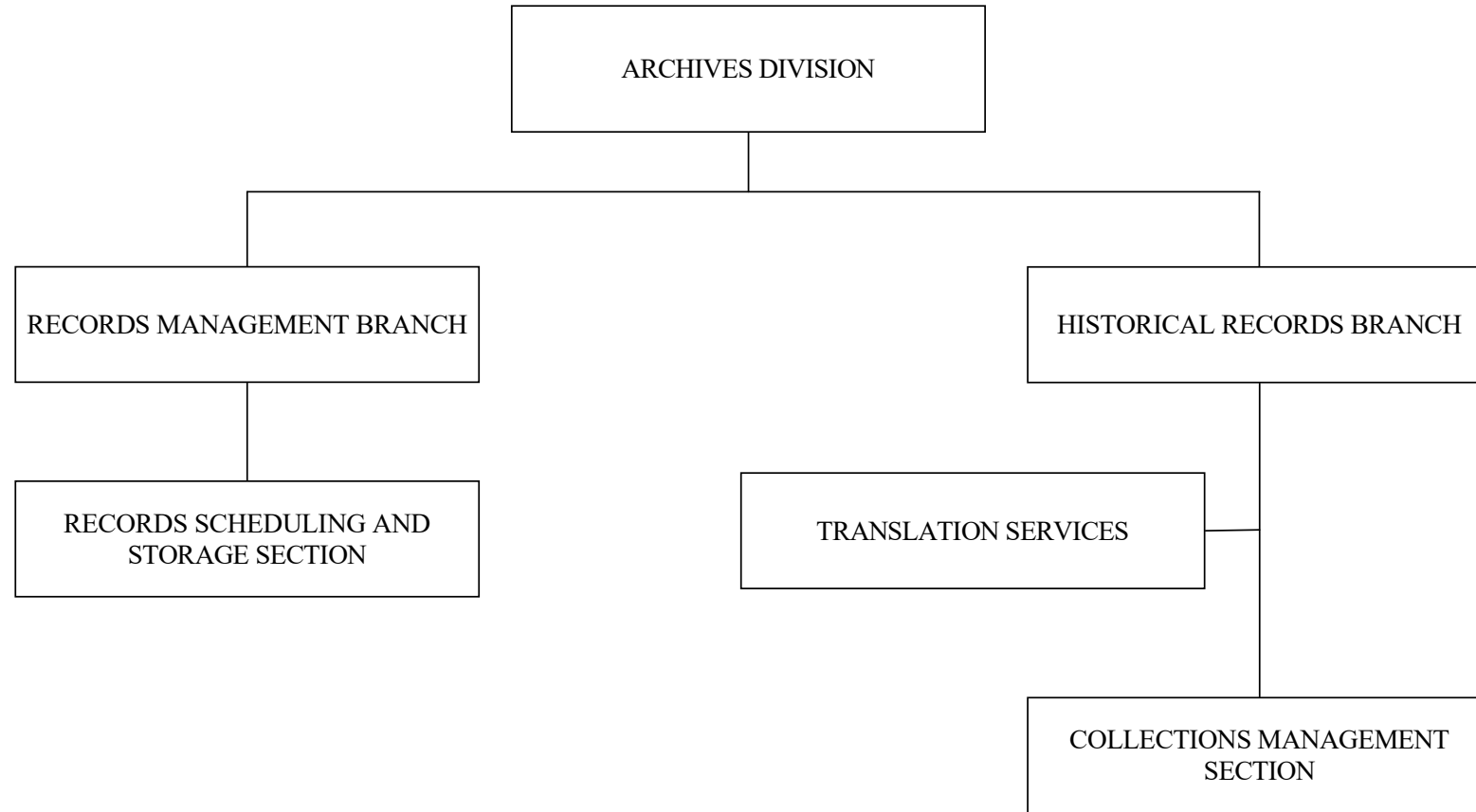

STATE OF HAWAII  
DEPARTMENT OF ACCOUNTING AND GENERAL SERVICES  
ARCHIVES DIVISION

POSITION ORGANIZATION CHART

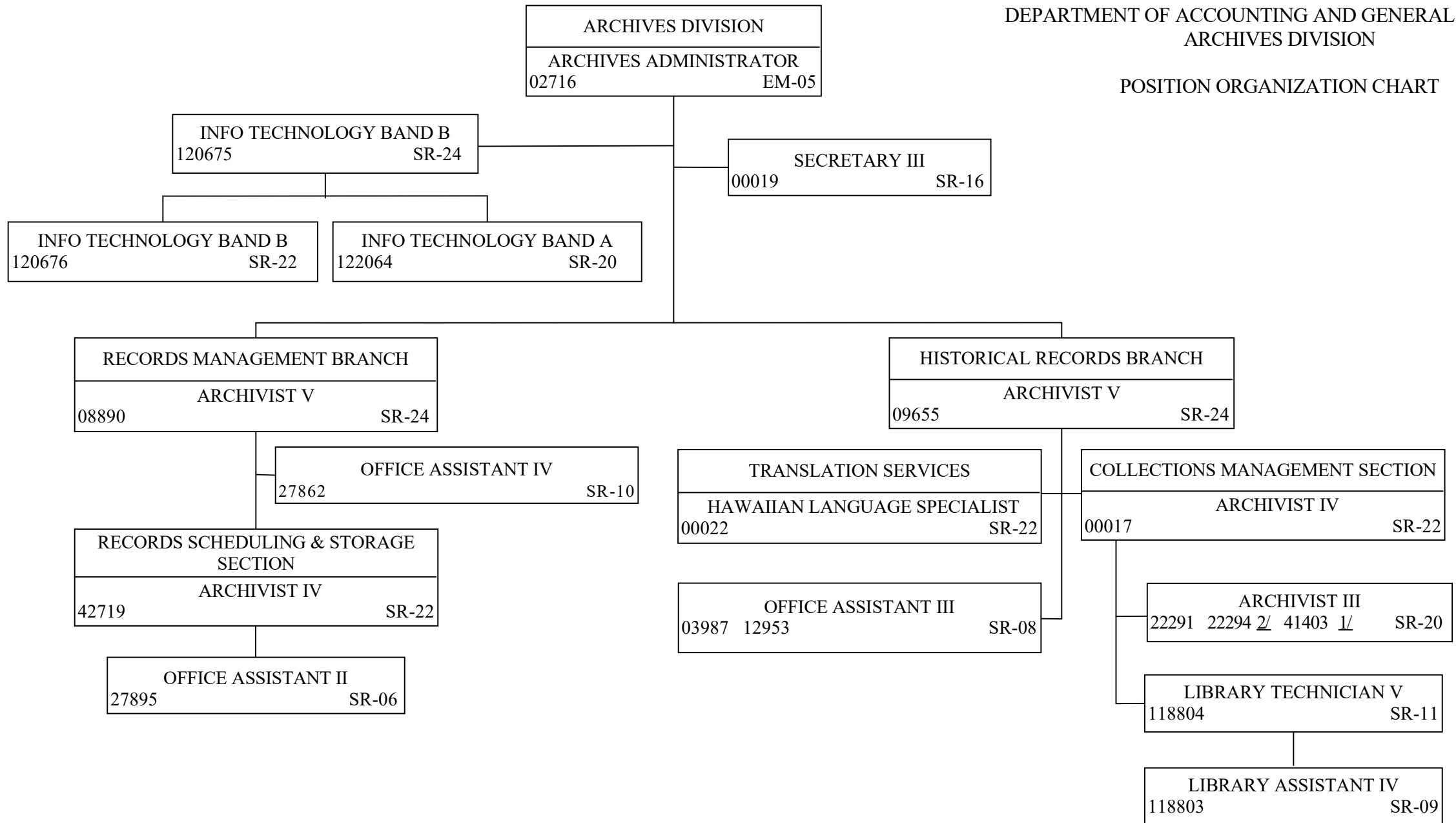

1/ POSITION NO. 41403 REALLOCATED TO ARCHIVIST II, SR-18, EFFECTIVE 06/05/19 AND WILL EVENTUALLY BE RESTORED TO ARCHIVIST III, SR-20.

2/ POSITION NO. 22294 REALLOCATED TO ARCHIVIST III, SR-20, EFFECTIVE 07/16/20.

STATE OF HAWAII  
DEPARTMENT OF ACCOUNTING AND GENERAL SERVICES  
AUTOMOTIVE MANAGEMENT DIVISION

ORGANIZATION CHART

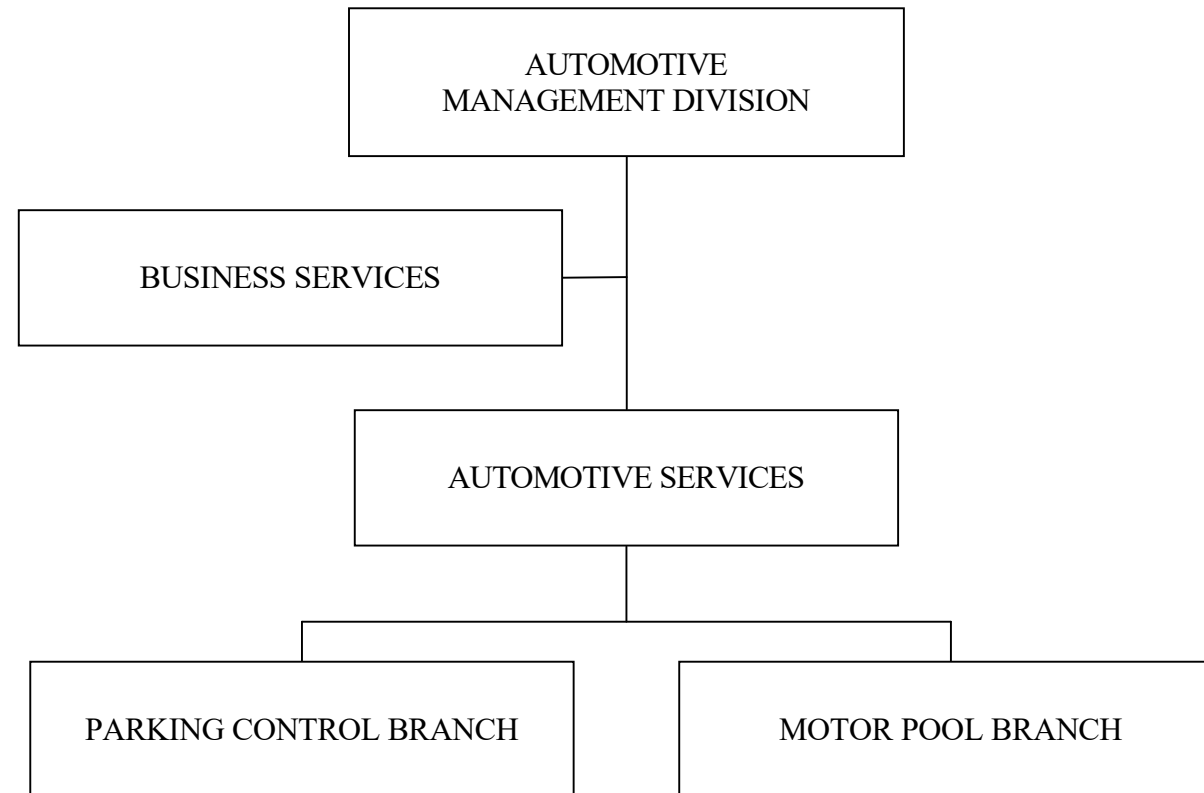

STATE OF HAWAII  
DEPARTMENT OF ACCOUNTING AND GENERAL SERVICES  
AUTOMOTIVE MANAGEMENT DIVISION

POSITION ORGANIZATION CHART

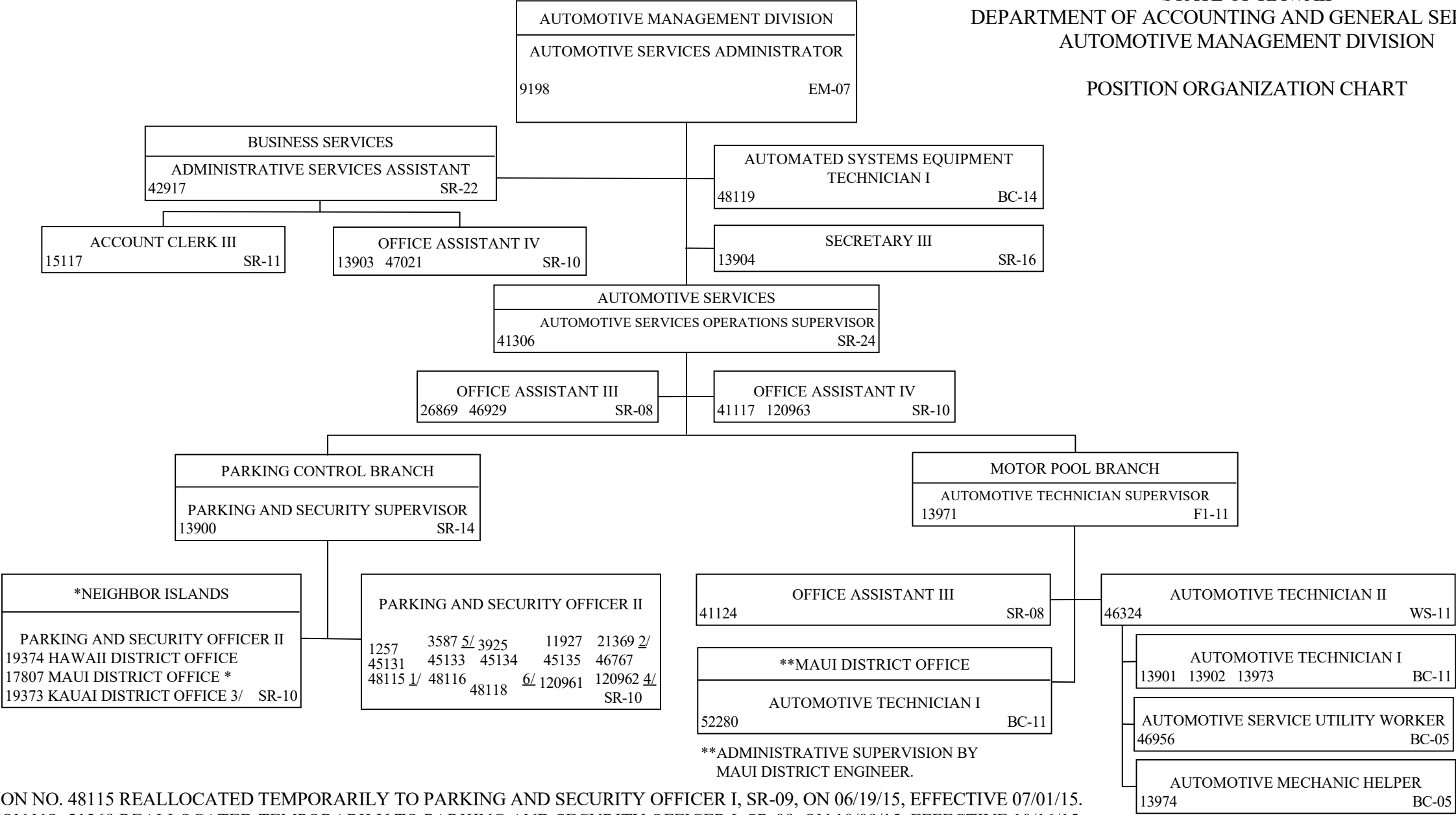

1/ POSITION NO. 48115 REALLOCATED TEMPORARILY TO PARKING AND SECURITY OFFICER I, SR-09, ON 06/19/15, EFFECTIVE 07/01/15.  
 2/ POSITION NO. 21369 REALLOCATED TEMPORARILY TO PARKING AND SECURITY OFFICER I, SR-09, ON 10/09/15, EFFECTIVE 10/16/15..  
 3/ POSITION NO. 19373 REALLOCATED BACK TO AUTHORIZED TO PARKING AND SECURITY OFFICER II, SR-10, ON AND EFFECTIVE 11/01/20.  
 4/ POSITION NO. 120962 REALLOCATED TEMPORARILY TO PARKING AND SECURITY OFFICER I, SR-09, ON 06/20/17, EFFECTIVE 07/01/17.  
 5/ POSITION NO. 3587 REALLOCATED TEMPORARILY TO PARKING AND SECURITY OFFICER I, SR-09, EFFECTIVE 01/01/15.  
 6/ POSITION NO. 48118 REALLOCATED TEMPORARILY TO PARKING AND SECURITY OFFICER I, SR-09, EFFECTIVE 07/11/18.

\*\*ADMINISTRATIVE SUPERVISION BY MAUI DISTRICT ENGINEER.

STATE OF HAWAII  
DEPARTMENT OF ACCOUNTING AND GENERAL SERVICES  
LAND SURVEY DIVISION

ORGANIZATION CHART

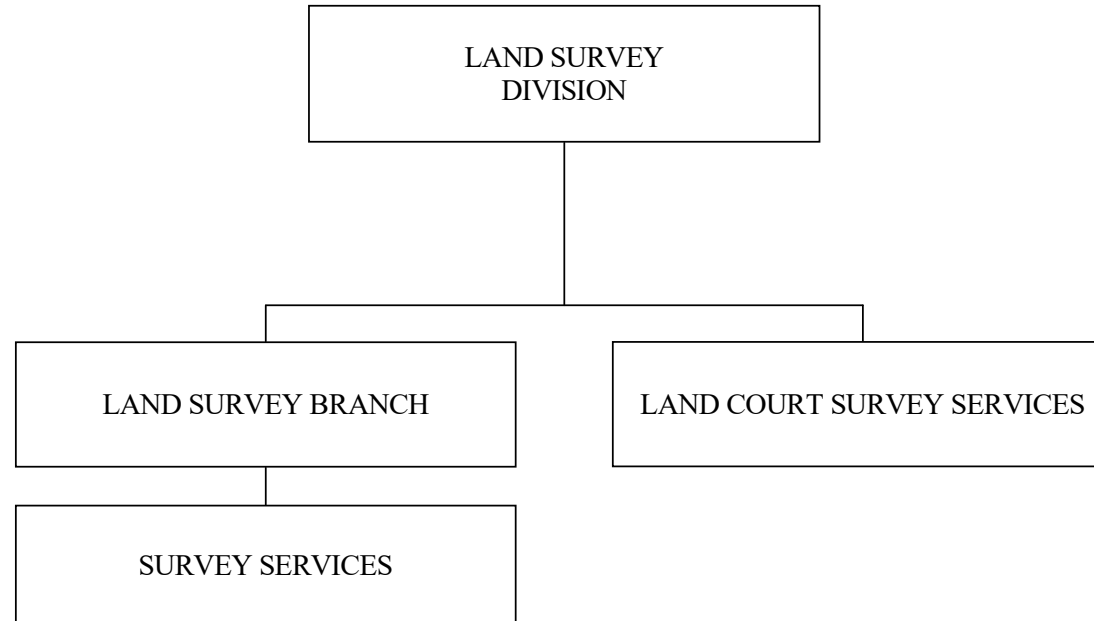

STATE OF HAWAII  
DEPARTMENT OF ACCOUNTING AND GENERAL SERVICES  
LAND SURVEY DIVISION

POSITION ORGANIZATION CHART

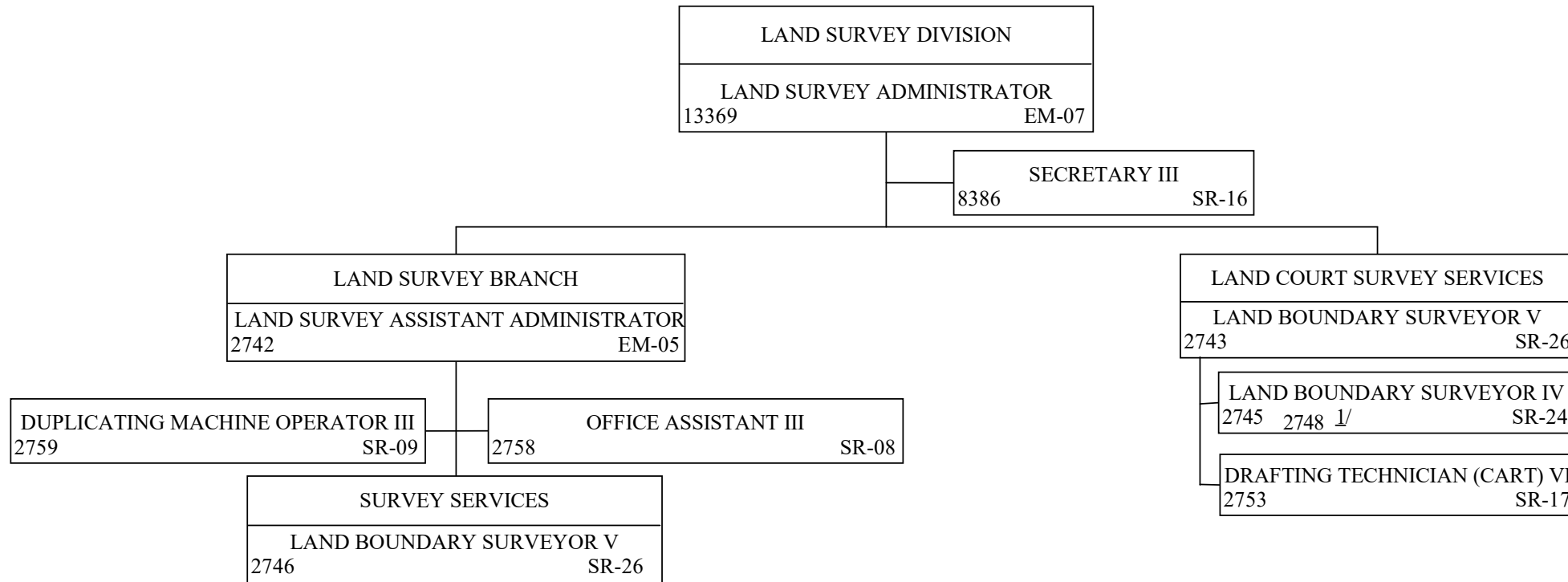

1/ POSITION NO. 2748 REALLOCATED TEMPORARILY TO LAND BOUNDARY SURVEYOR III, SR-22, ON 03/27/14, EFFECTIVE 04/01/14.



STATE OF HAWAII  
DEPARTMENT OF ACCOUNTING AND GENERAL SERVICES  
HAWAII DISTRICT OFFICE

ORGANIZATION CHART

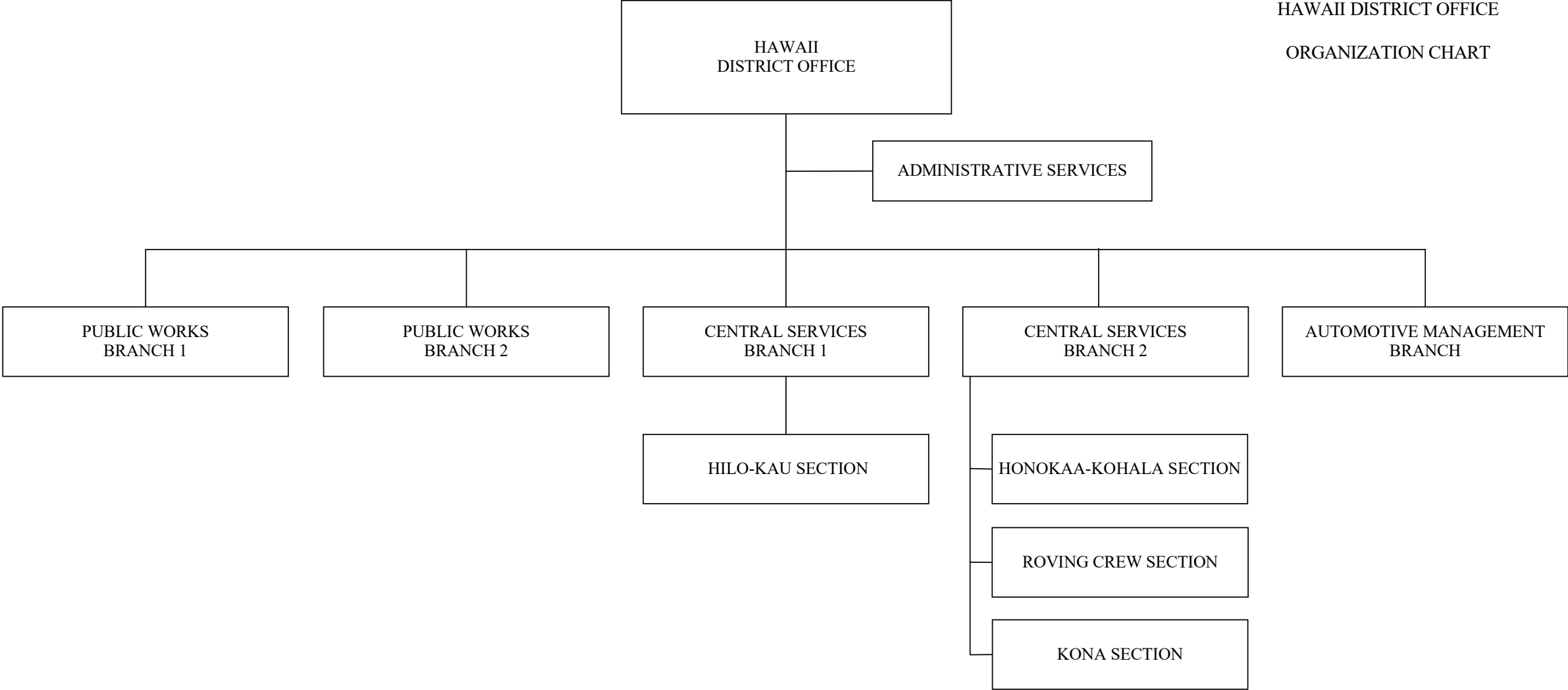

STATE OF HAWAII  
DEPARTMENT OF ACCOUNTING AND GENERAL SERVICES  
HAWAII DISTRICT OFFICE

POSITION ORGANIZATION CHART

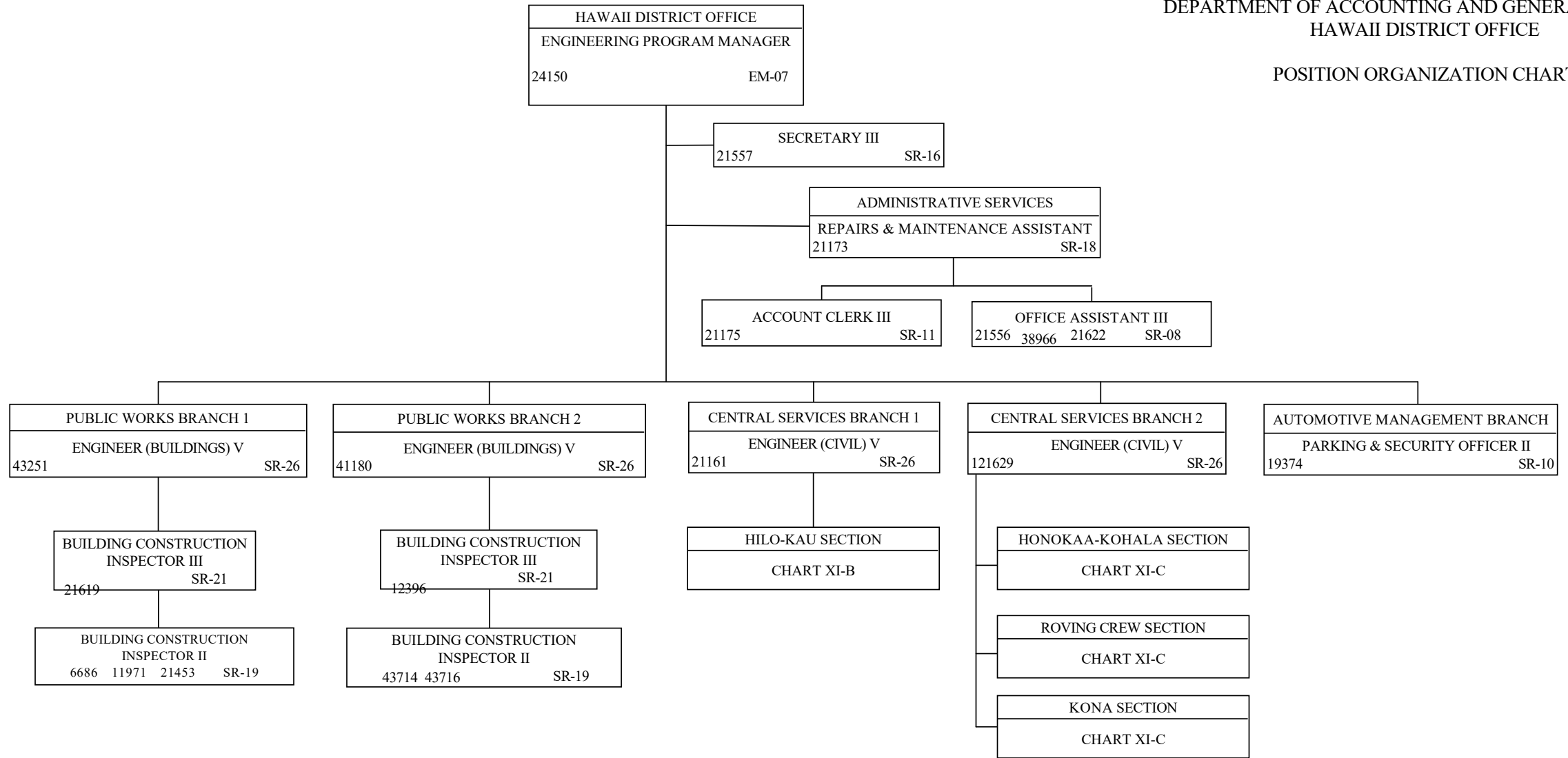

STATE OF HAWAII  
 DEPARTMENT OF ACCOUNTING AND GENERAL SERVICES  
 HAWAII DISTRICT OFFICE  
 CENTRAL SERVICES BRANCH 1  
 HILO-KAU SECTION

POSITION ORGANIZATION CHART

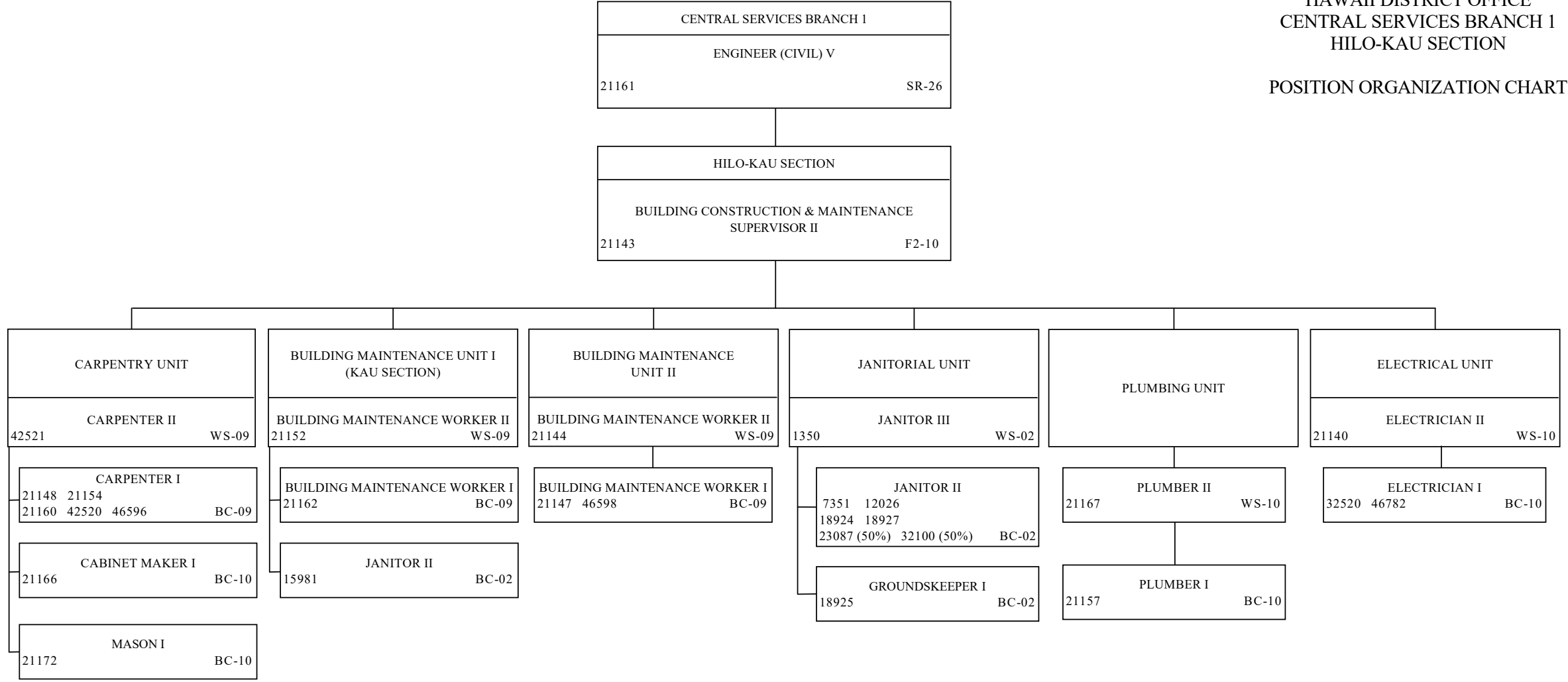

STATE OF HAWAII  
 DEPARTMENT OF ACCOUNTING AND GENERAL SERVICES  
 HAWAII DISTRICT OFFICE  
 CENTRAL SERVICES BRANCH 2  
 HONOKAA-KOHALA SECTION, ROVING CREW SECTION, AND KONA SECTION

POSITION ORGANIZATION CHART

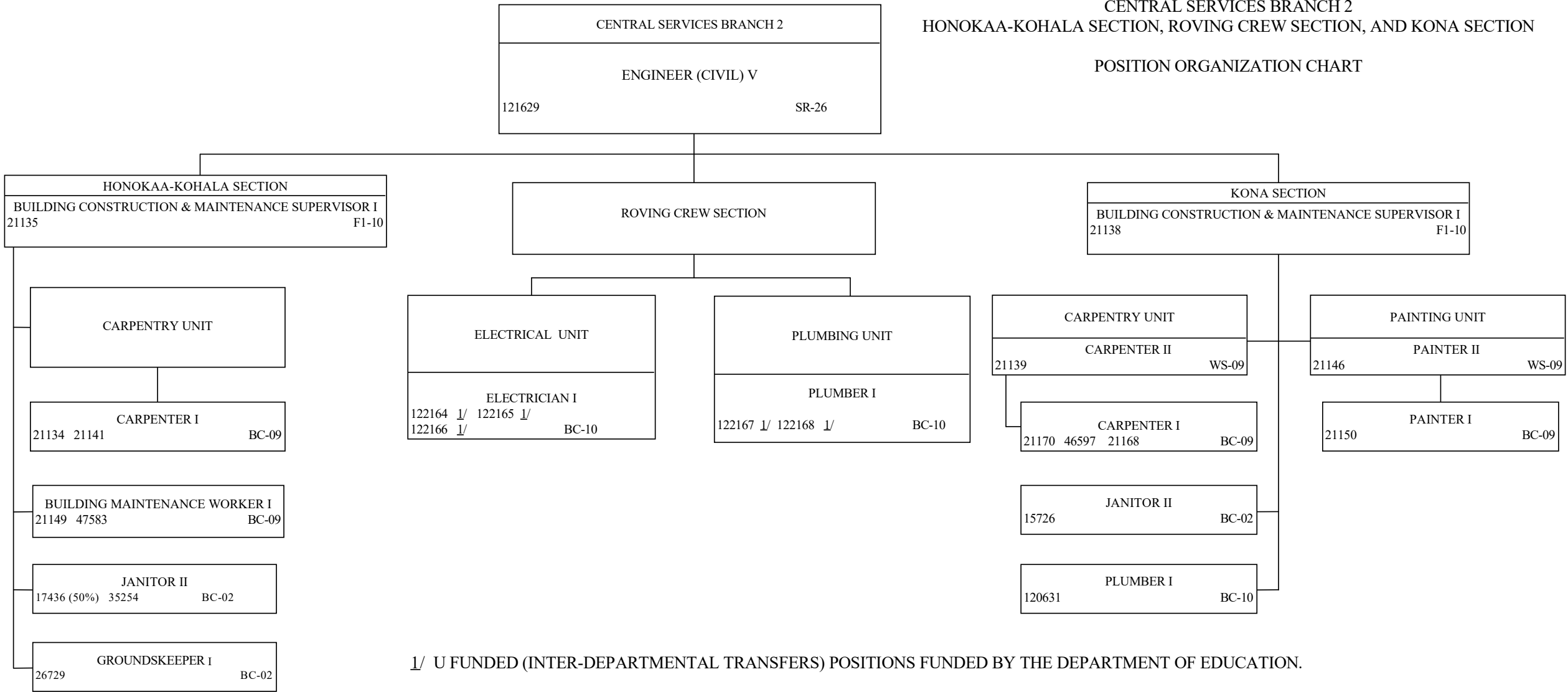

1/ U FUNDED (INTER-DEPARTMENTAL TRANSFERS) POSITIONS FUNDED BY THE DEPARTMENT OF EDUCATION.

STATE OF HAWAII  
DEPARTMENT OF ACCOUNTING AND GENERAL SERVICES  
MAUI DISTRICT OFFICE

ORGANIZATION CHART

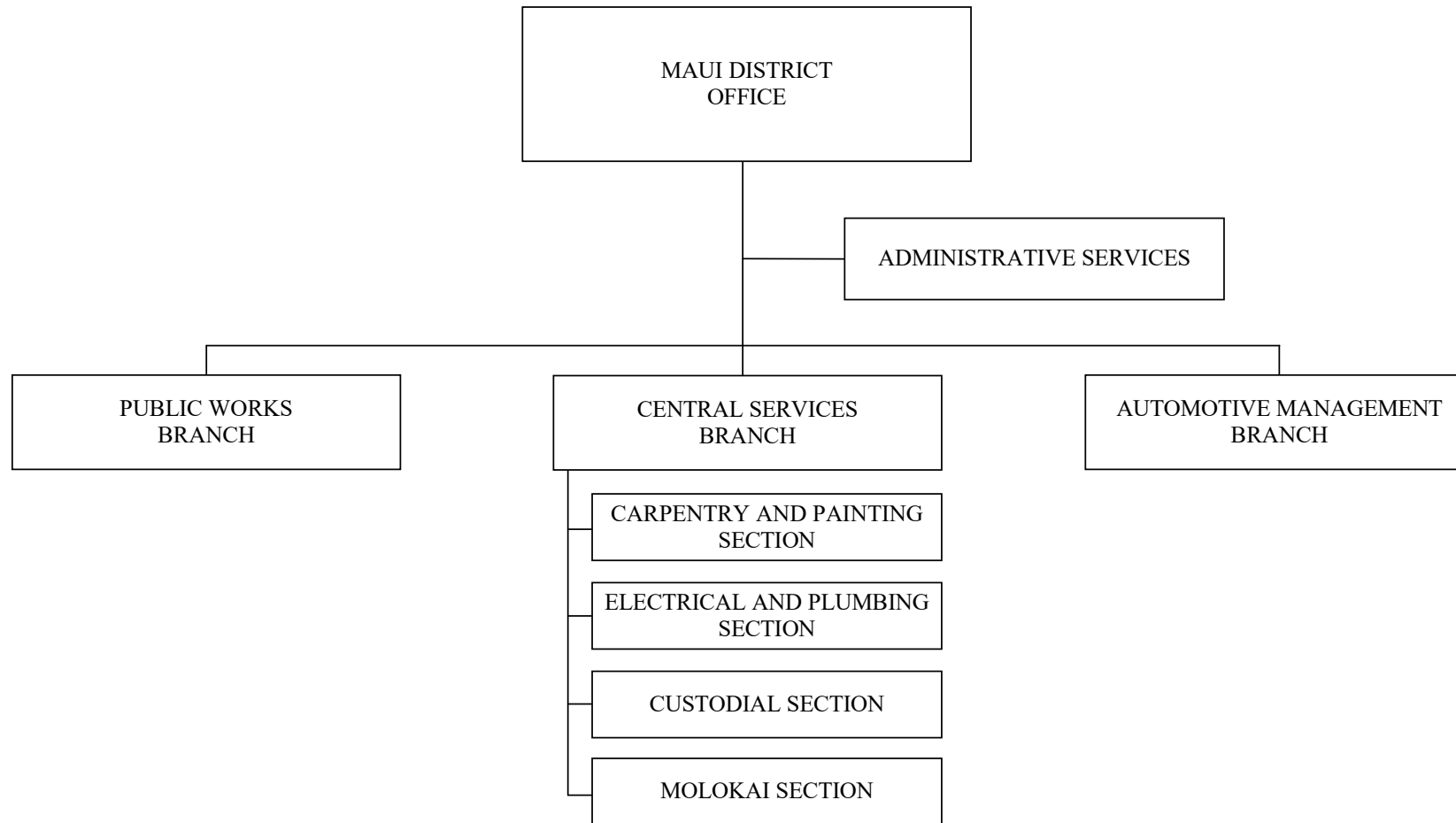

STATE OF HAWAII  
DEPARTMENT OF ACCOUNTING AND GENERAL SERVICES  
MAUI DISTRICT OFFICE

POSITION ORGANIZATION CHART

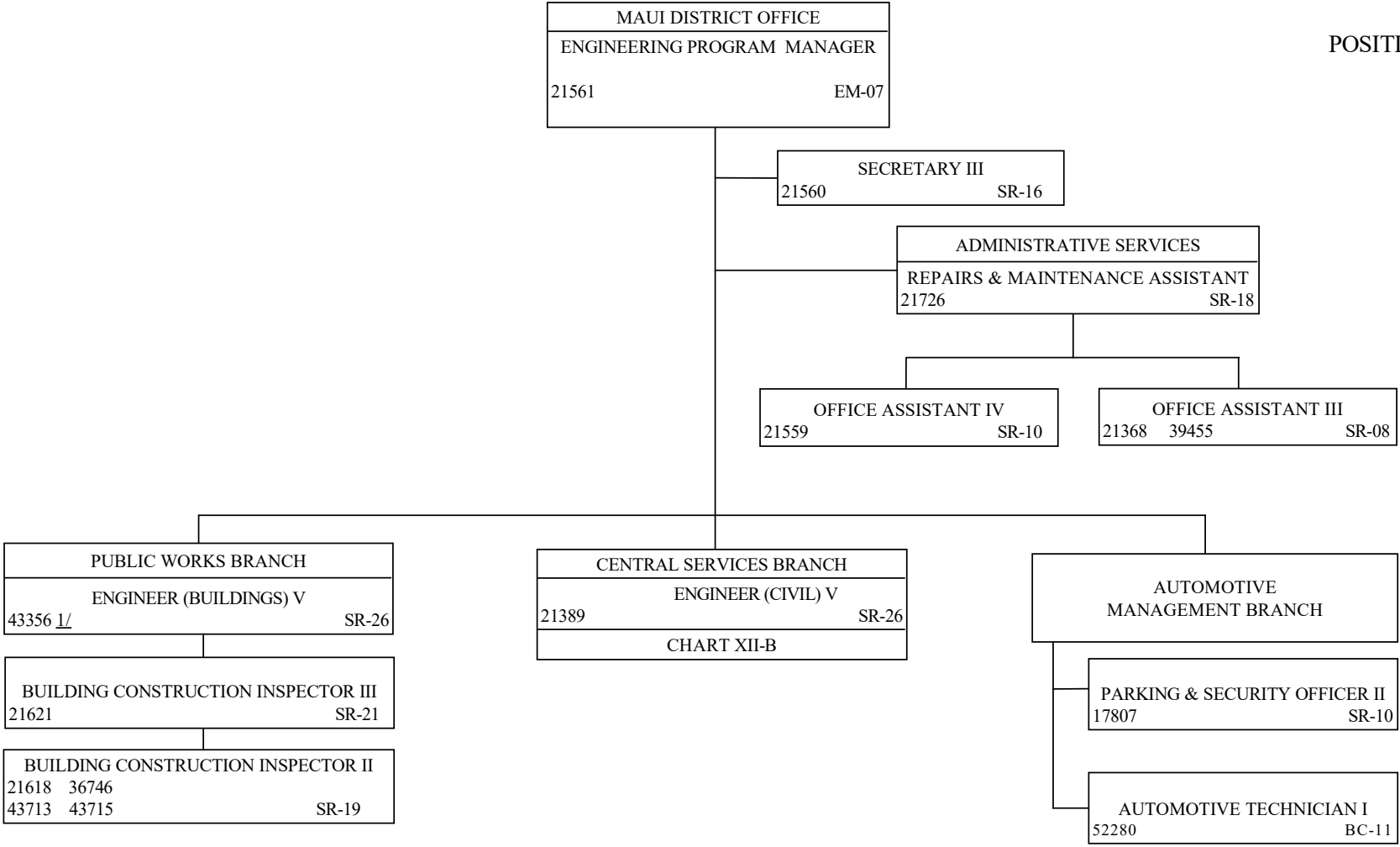

1/ POSITION NO. 43356, REALLOCATED TO ENGINEER (BUILDINGS) III, SR-22, EFFECTIVE 07/29/19.

STATE OF HAWAII  
DEPARTMENT OF ACCOUNTING AND GENERAL SERVICES  
MAUI DISTRICT OFFICE  
CENTRAL SERVICES BRANCH

POSITION ORGANIZATION CHART

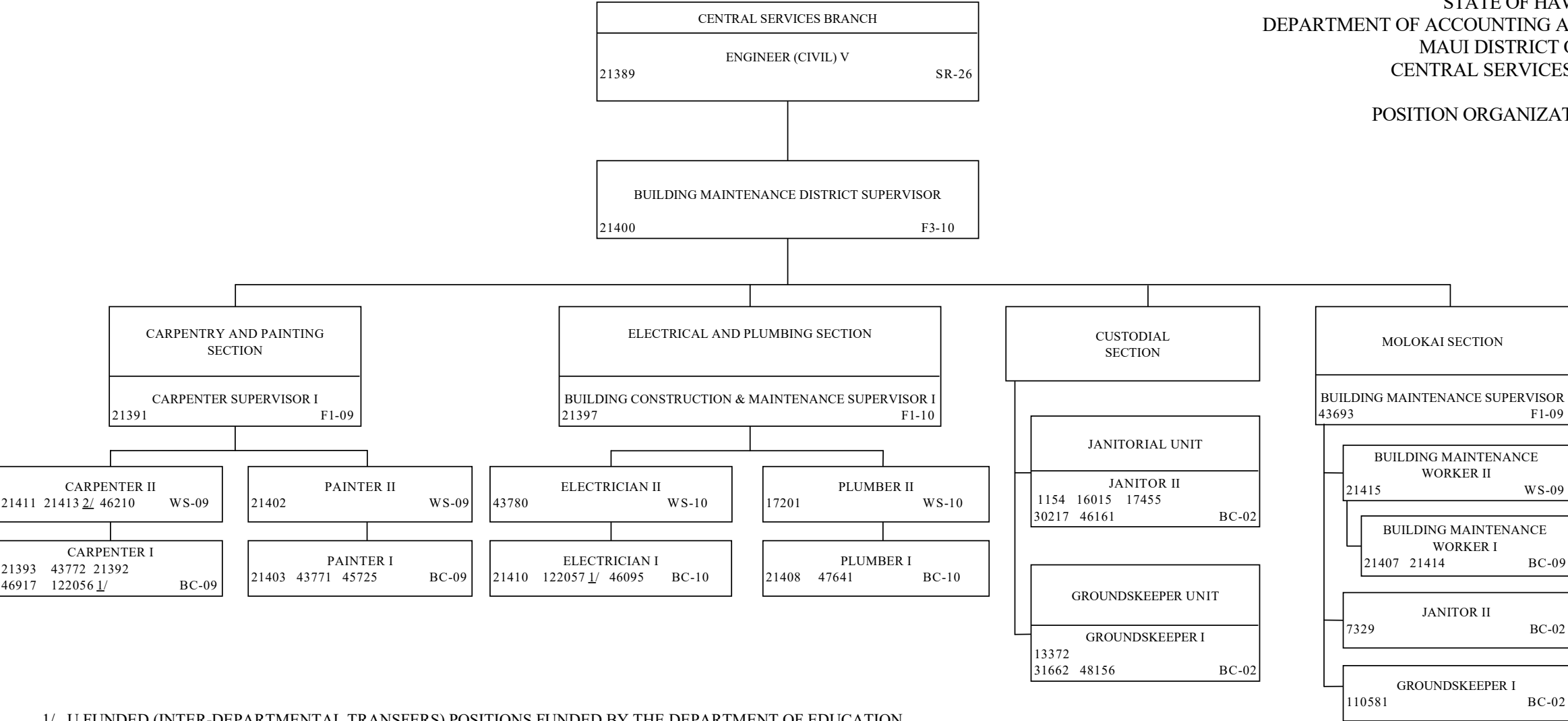

1/ U FUNDED (INTER-DEPARTMENTAL TRANSFERS) POSITIONS FUNDED BY THE DEPARTMENT OF EDUCATION.

2/ POSITION NO. 21413 REALLOCATED TO A CARPENTER I, BC-09, EFFECTIVE 10/03/18.

STATE OF HAWAII  
DEPARTMENT OF ACCOUNTING AND GENERAL SERVICES  
KAUAI DISTRICT OFFICE  
ORGANIZATION CHART

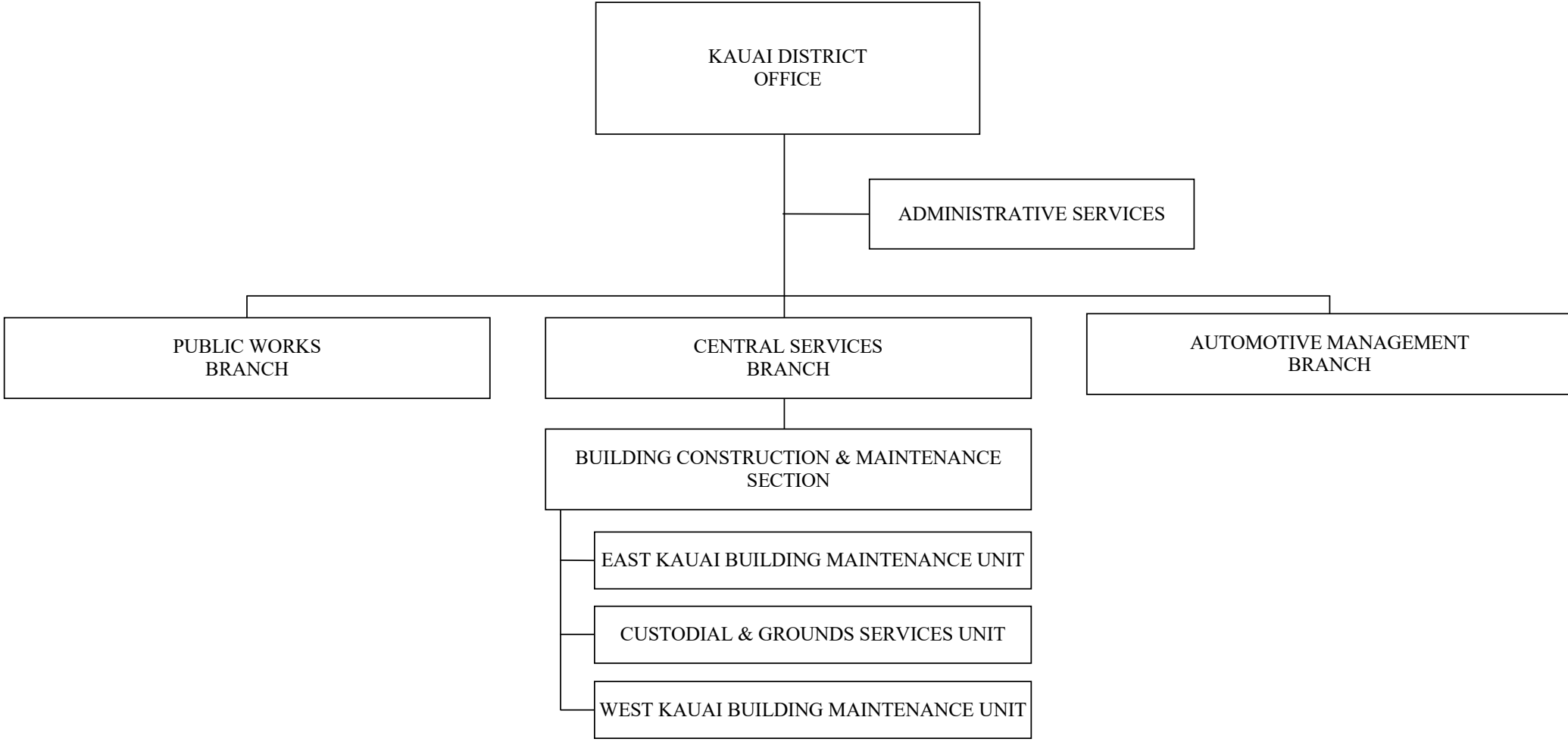



STATE OF HAWAII  
DEPARTMENT OF ACCOUNTING AND GENERAL SERVICES  
KAUAI DISTRICT OFFICE

POSITION ORGANIZATION CHART

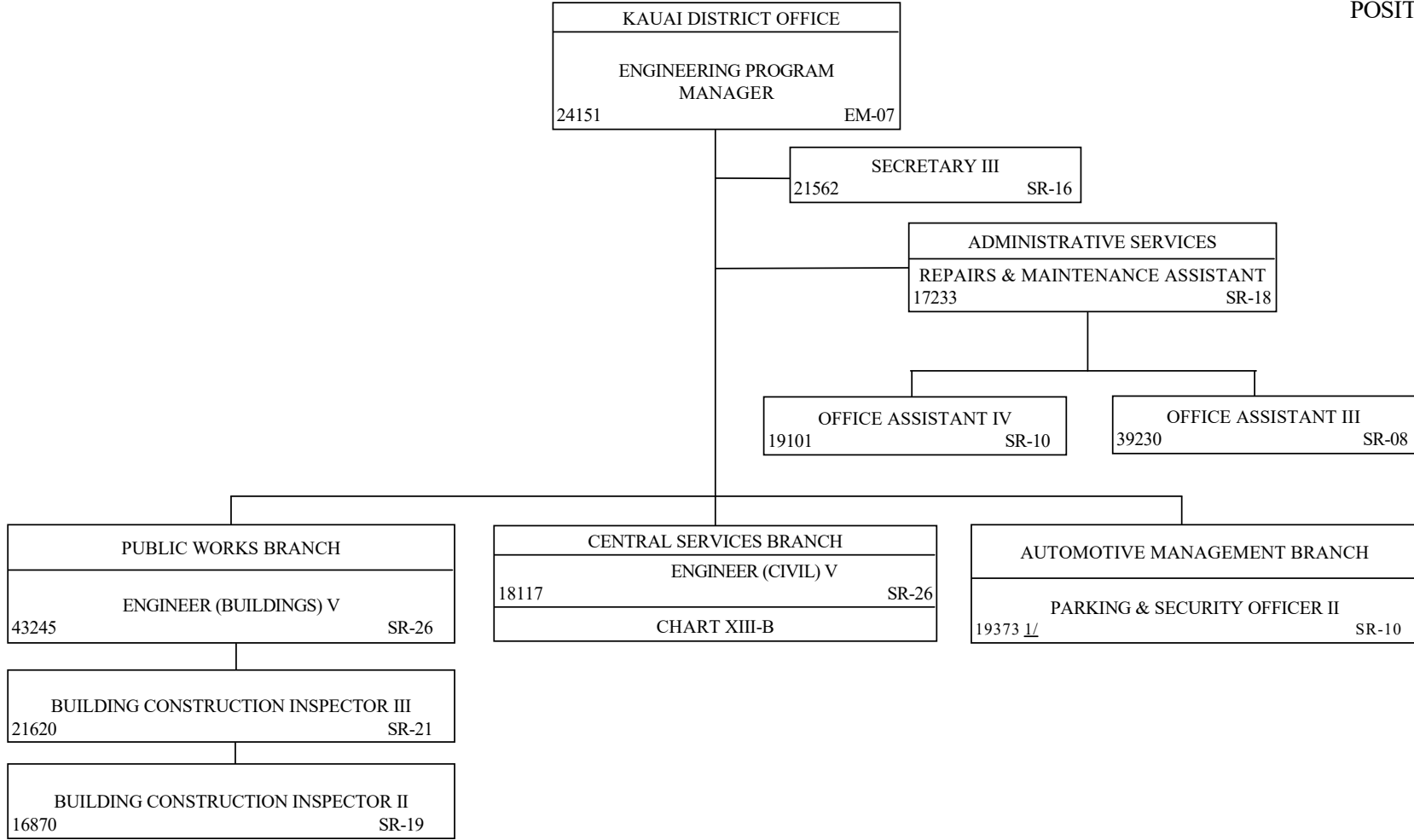

1/ POSITION NO. 19373 REALLOCATED BACK TO AUTHORIZED TO PARKING AND SECURITY OFFICER II, SR-10, ON AND EFFECTIVE 11/01/20.

STATE OF HAWAII  
DEPARTMENT OF ACCOUNTING AND GENERAL SERVICES  
KAUAI DISTRICT OFFICE  
CENTRAL SERVICES BRANCH

POSITION ORGANIZATION CHART

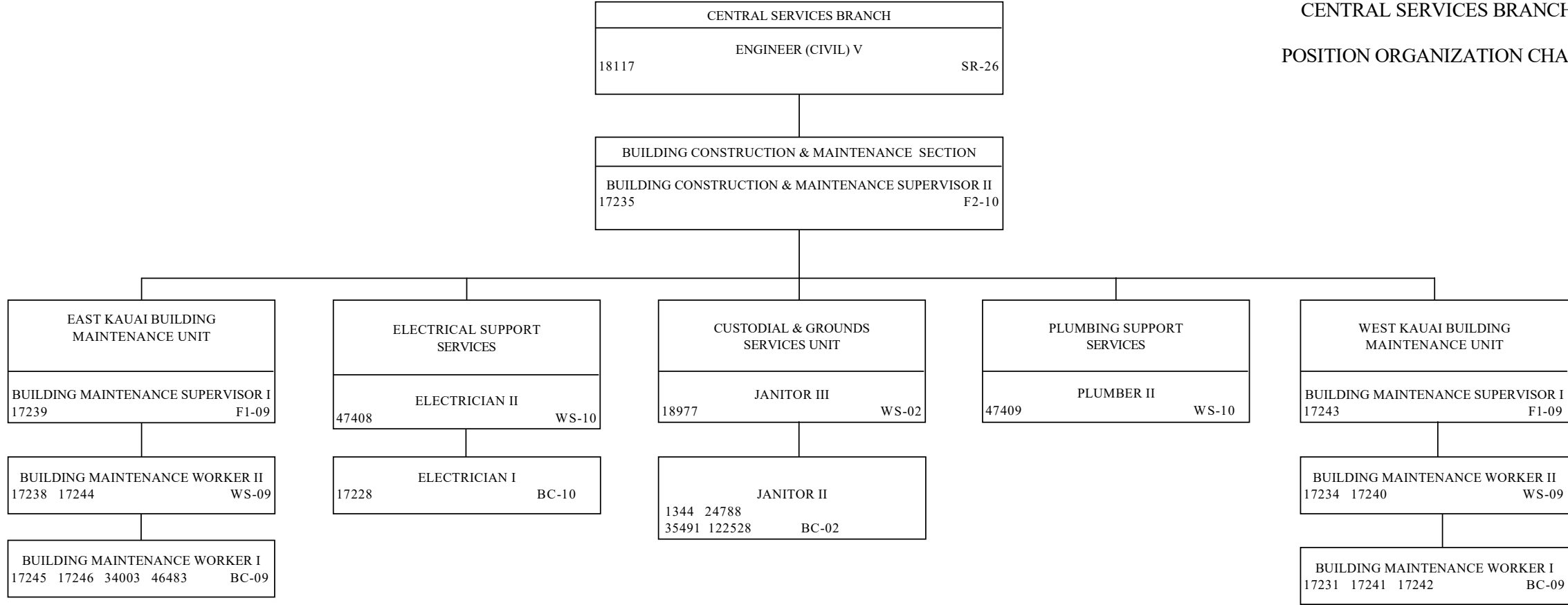

STATE OF HAWAII  
DEPARTMENT OF ACCOUNTING AND GENERAL SERVICES  
STATE FOUNDATION ON CULTURE AND THE ARTS

ORGANIZATION CHART

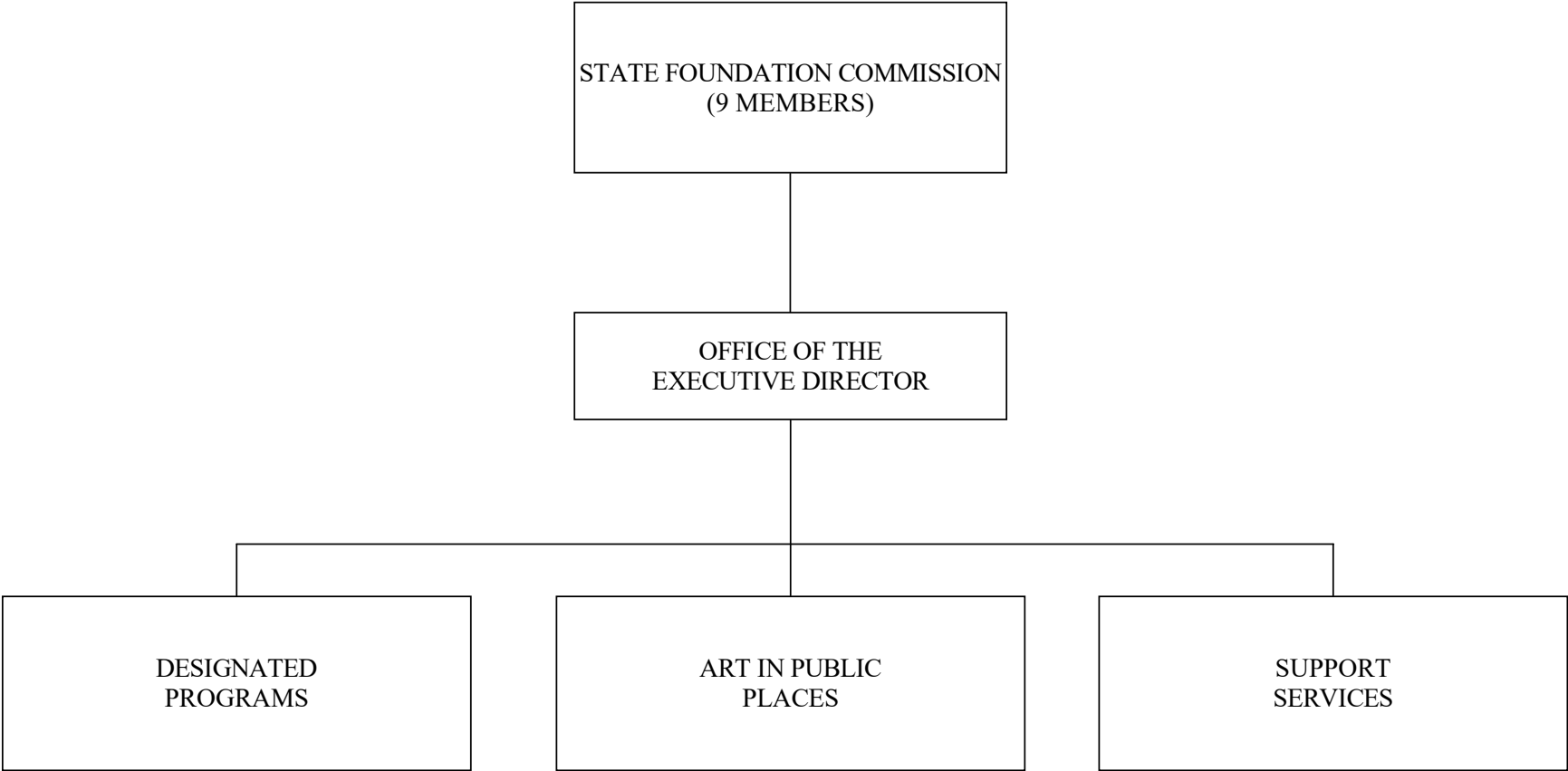

STATE OF HAWAII  
DEPARTMENT OF ACCOUNTING AND GENERAL SERVICES  
STATE FOUNDATION ON CULTURE AND THE ARTS

POSITION ORGANIZATION CHART

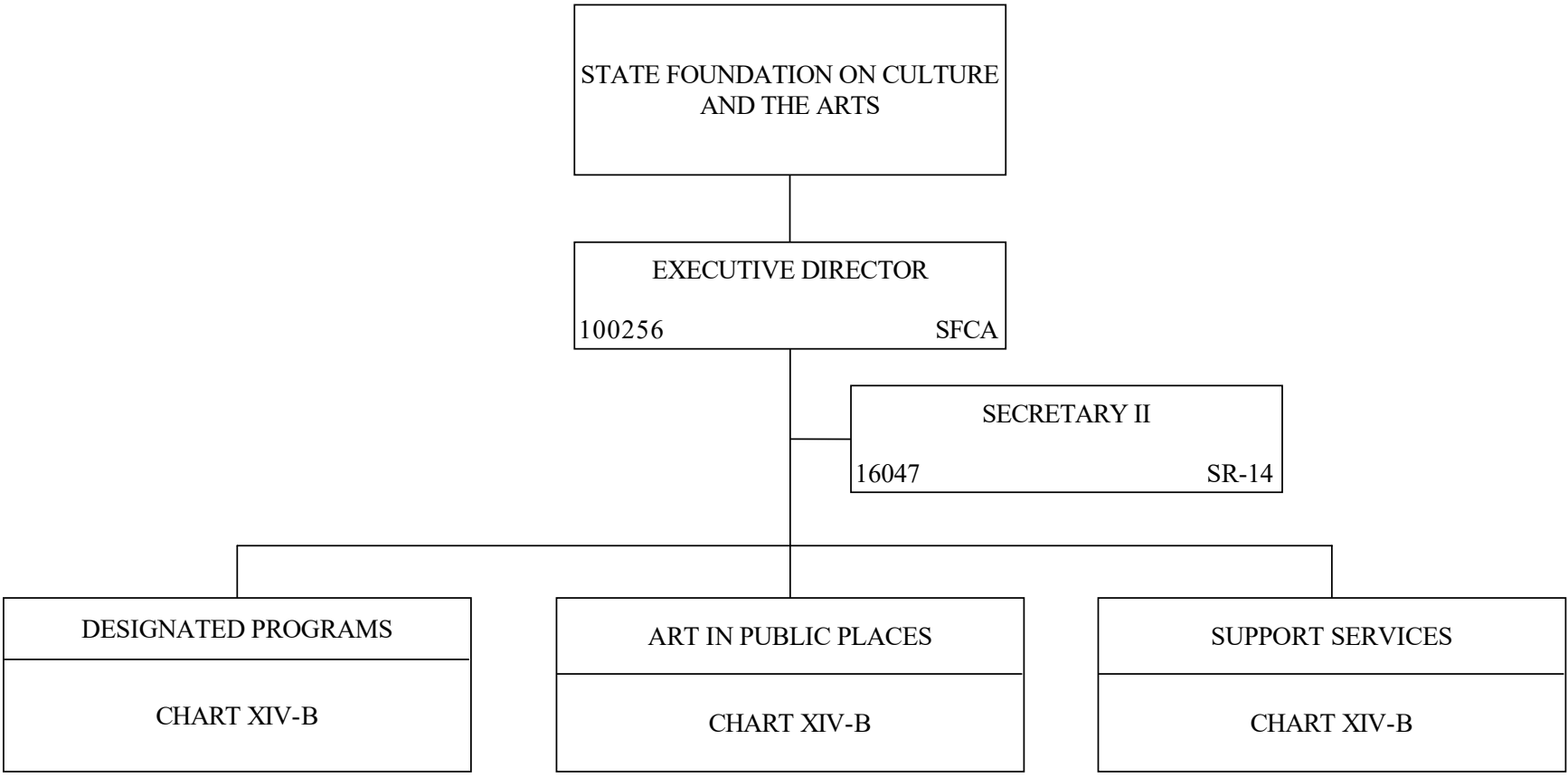

STATE OF HAWAII  
 DEPARTMENT OF ACCOUNTING AND GENERAL SERVICES  
 STATE FOUNDATION ON CULTURE AND THE ARTS  
 DESIGNATED PROGRAMS, ART IN PUBLIC PLACES,  
 AND SUPPORT SERVICES

POSITION ORGANIZATION CHART

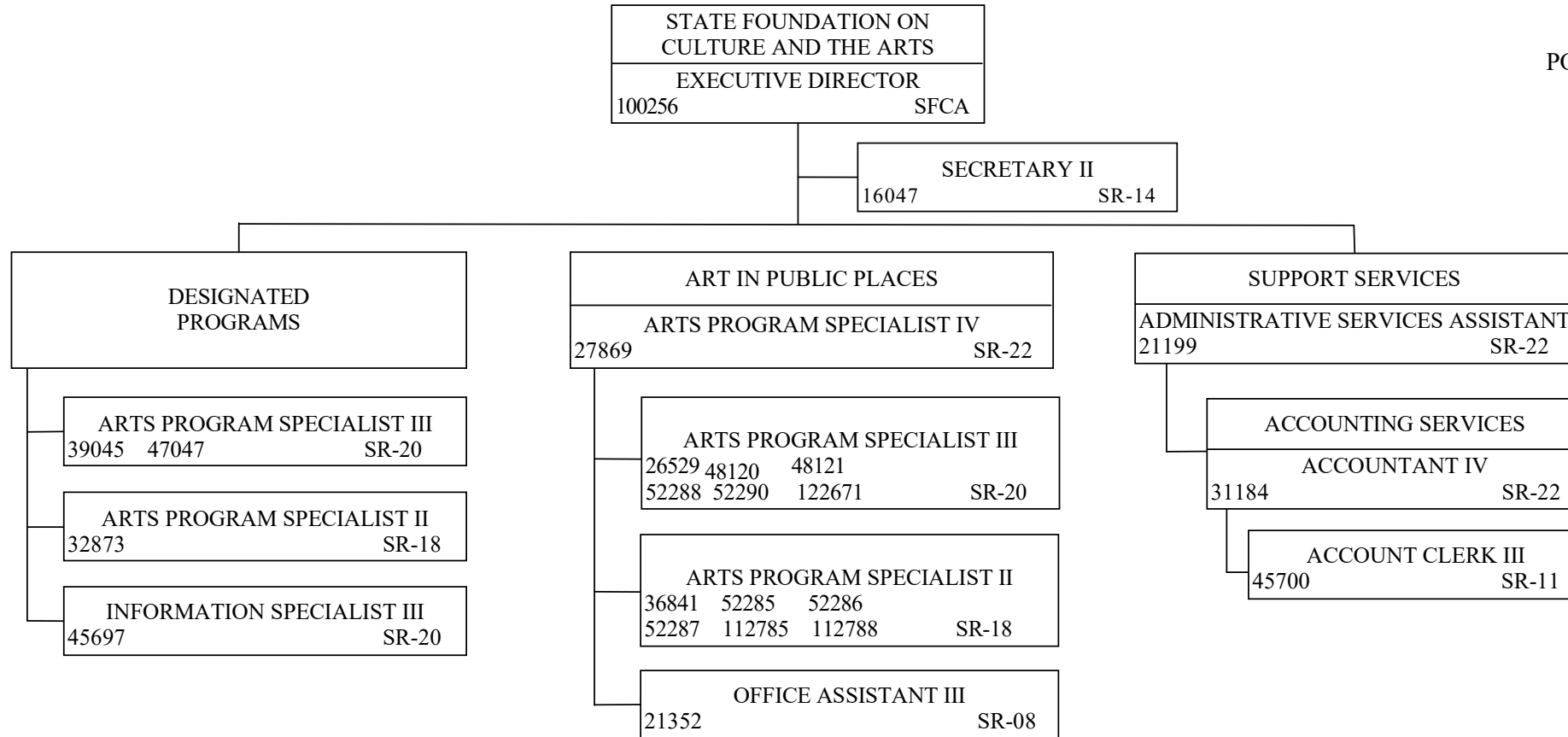

STATE OF HAWAII  
DEPARTMENT OF ACCOUNTING AND GENERAL SERVICES  
KING KAMEHAMEHA CELEBRATION COMMISSION

ORGANIZATION CHART



STATE OF HAWAII  
DEPARTMENT OF ACCOUNTING AND GENERAL SERVICES  
KING KAMEHAMEHA CELEBRATION COMMISSION

POSITION ORGANIZATION CHART

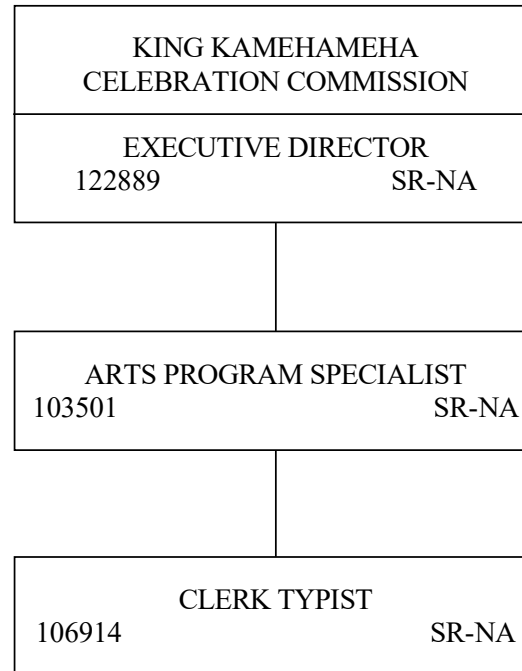

STATE OF HAWAII  
 DEPARTMENT OF ACCOUNTING AND GENERAL SERVICES  
 STADIUM AUTHORITY  
 ORGANIZATION CHART

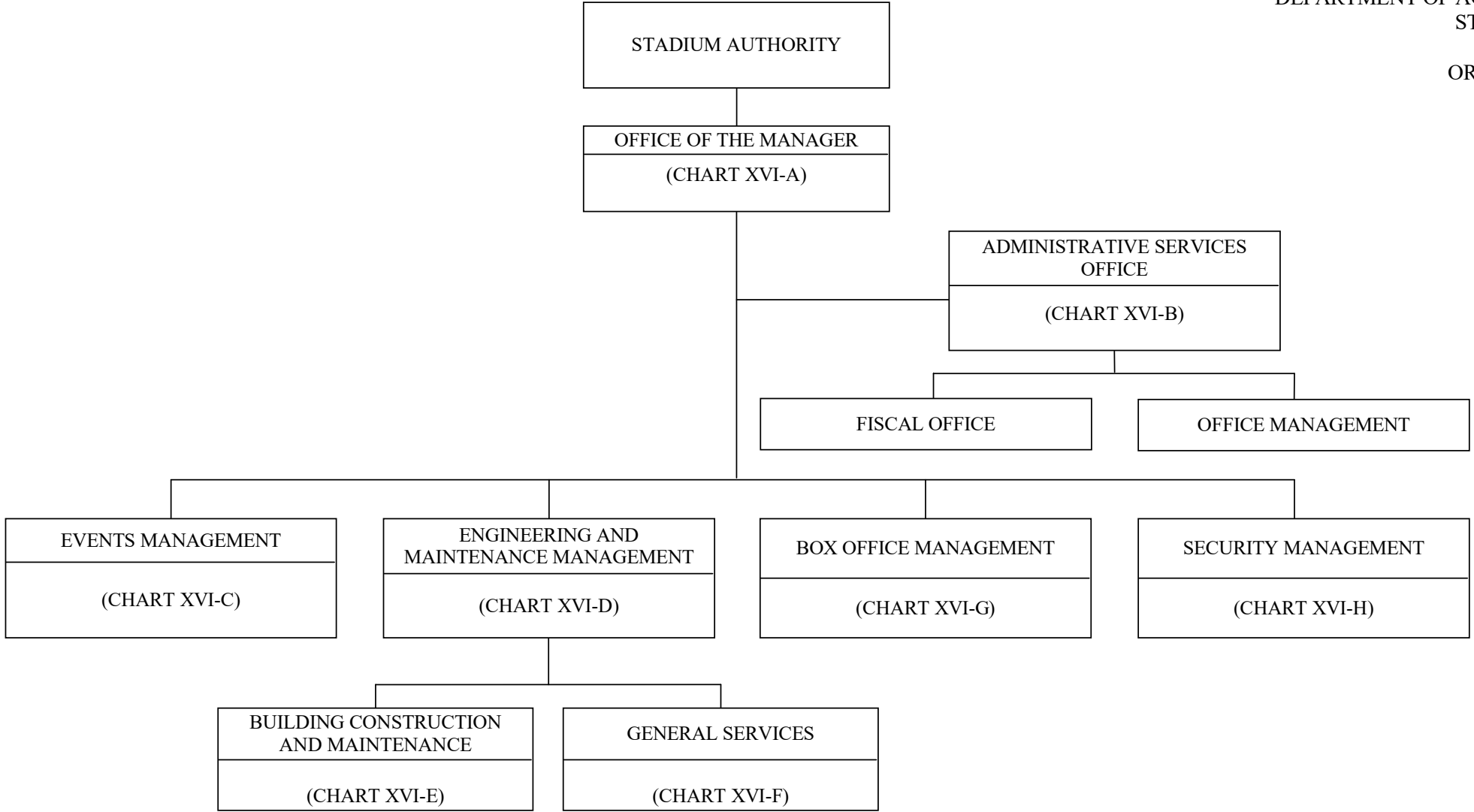



STATE OF HAWAII  
DEPARTMENT OF ACCOUNTING AND GENERAL SERVICES  
STADIUM AUTHORITY  
OFFICE OF THE MANAGER

POSITION ORGANIZATION CHART

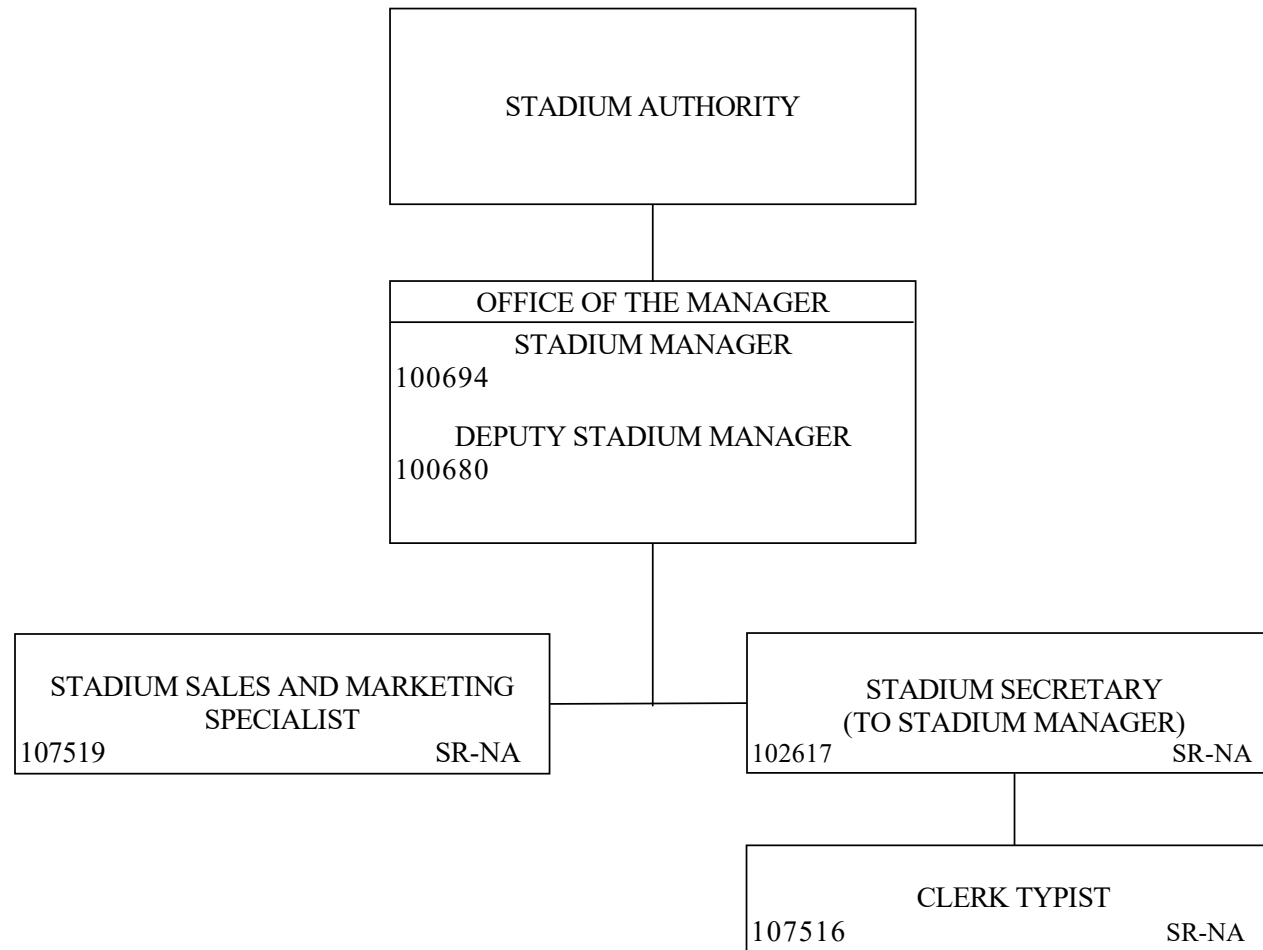

STATE OF HAWAII  
 DEPARTMENT OF ACCOUNTING AND GENERAL SERVICES  
 STADIUM AUTHORITY  
 ADMINISTRATIVE SERVICES OFFICE  
 POSITION ORGANIZATION CHART

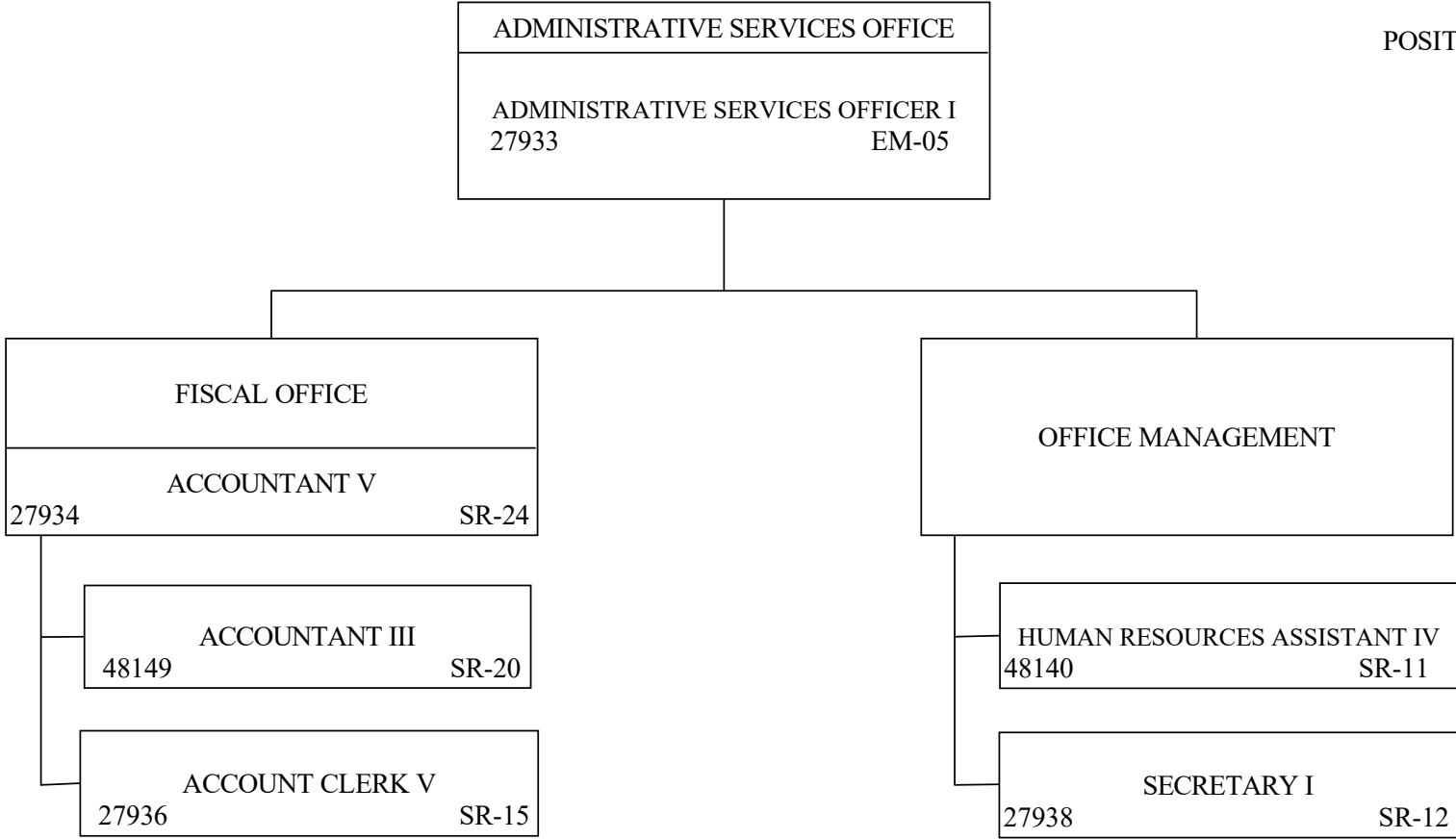

STATE OF HAWAII  
DEPARTMENT OF ACCOUNTING AND GENERAL SERVICES  
STADIUM AUTHORITY  
EVENTS MANAGEMENT BRANCH  
  
POSITION ORGANIZATION CHART

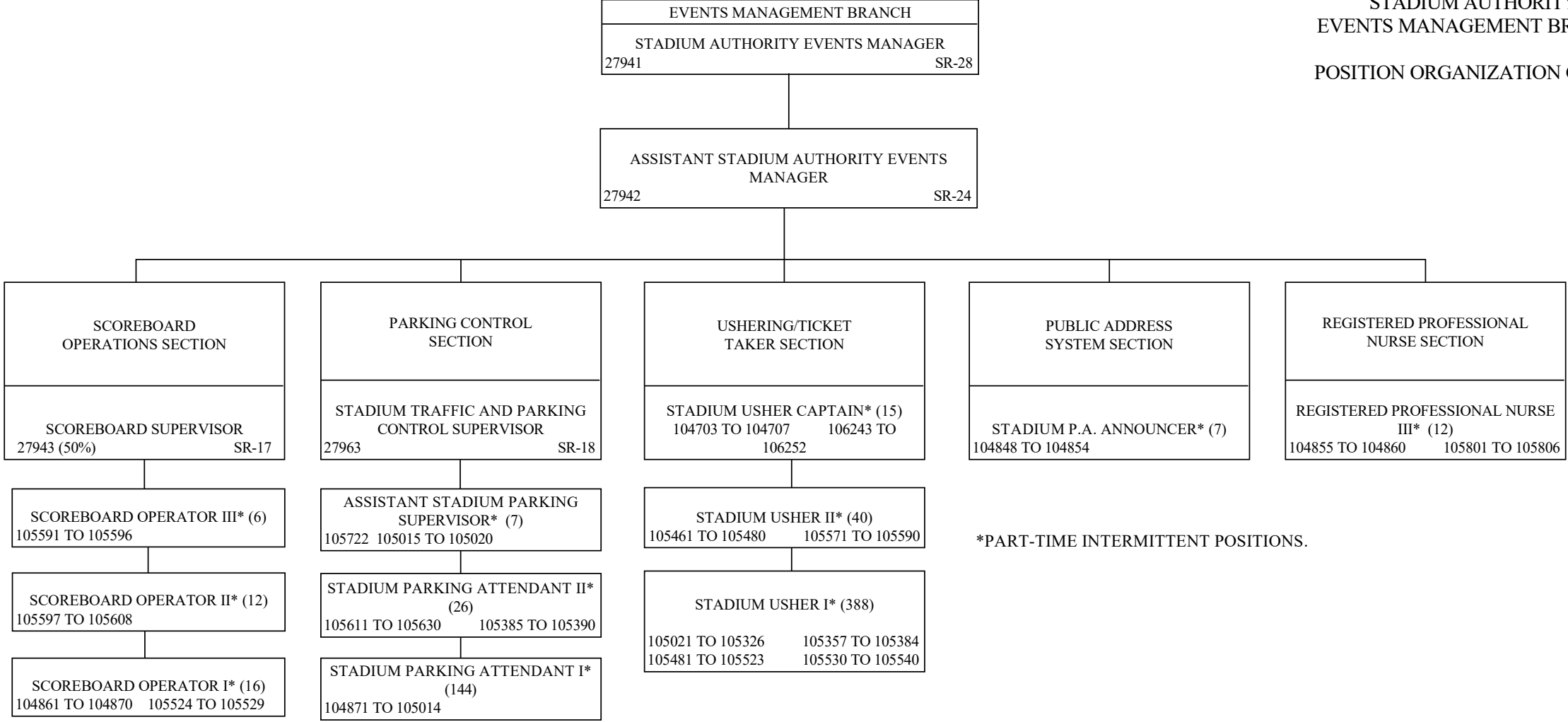

\*PART-TIME INTERMITTENT POSITIONS.

STATE OF HAWAII  
 DEPARTMENT OF ACCOUNTING AND GENERAL SERVICES  
 STADIUM AUTHORITY  
 ENGINEERING AND MAINTENANCE BRANCH

POSITION ORGANIZATION CHART

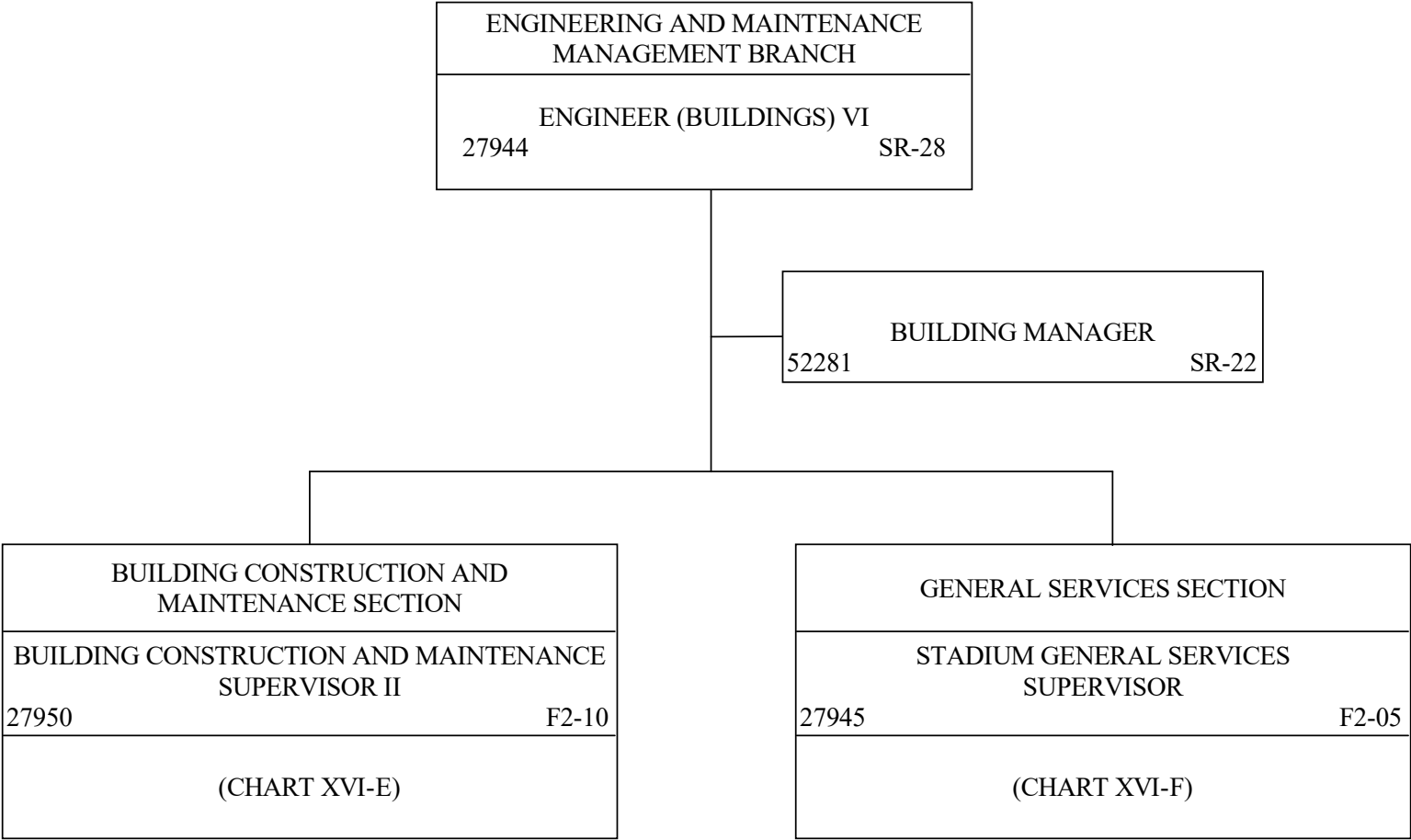

STATE OF HAWAII  
DEPARTMENT OF ACCOUNTING AND GENERAL SERVICES  
STADIUM AUTHORITY  
ENGINEERING AND MAINTENANCE MANAGEMENT BRANCH  
BUILDING CONSTRUCTION AND MAINTENANCE SECTION

POSITION ORGANIZATION CHART

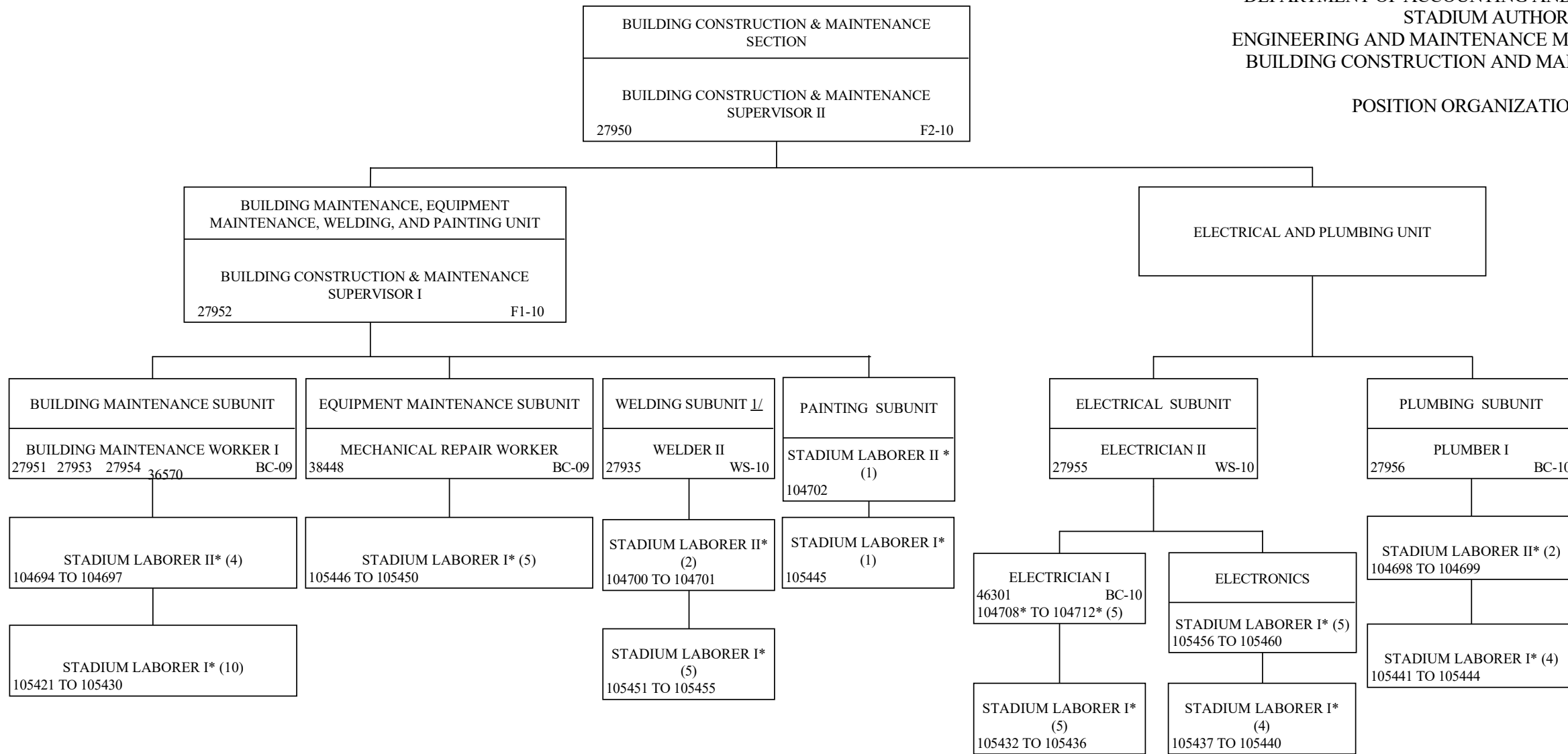

\*PART-TIME INTERMITTENT POSITIONS.

STATE OF HAWAII  
DEPARTMENT OF ACCOUNTING AND GENERAL SERVICES  
STADIUM AUTHORITY  
ENGINEERING AND MAINTENANCE MANAGEMENT BRANCH  
GENERAL SERVICES SECTION

POSITION ORGANIZATION CHART

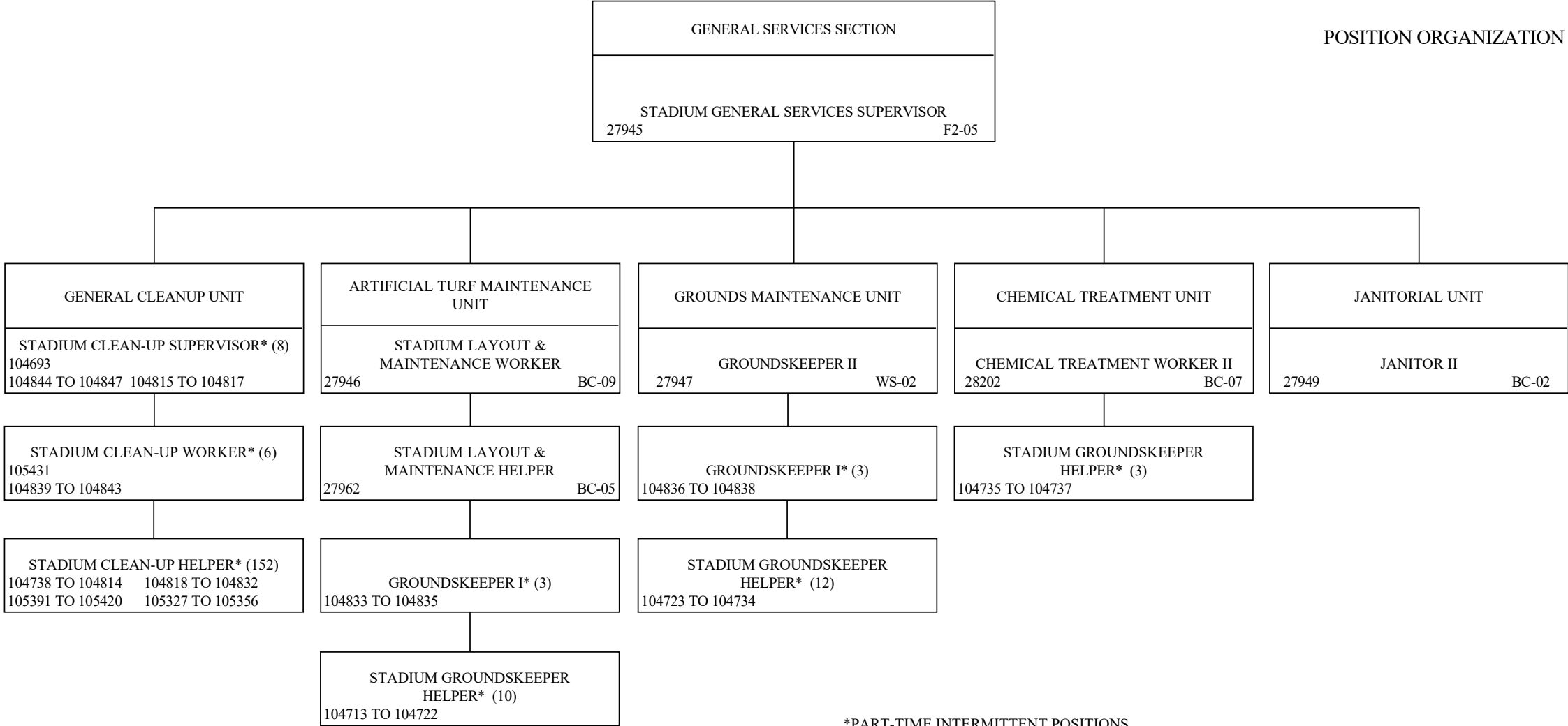

\*PART-TIME INTERMITTENT POSITIONS.

STATE OF HAWAII  
DEPARTMENT OF ACCOUNTING AND GENERAL SERVICES  
STADIUM AUTHORITY  
BOX OFFICE MANAGEMENT BRANCH

POSITION ORGANIZATION CHART

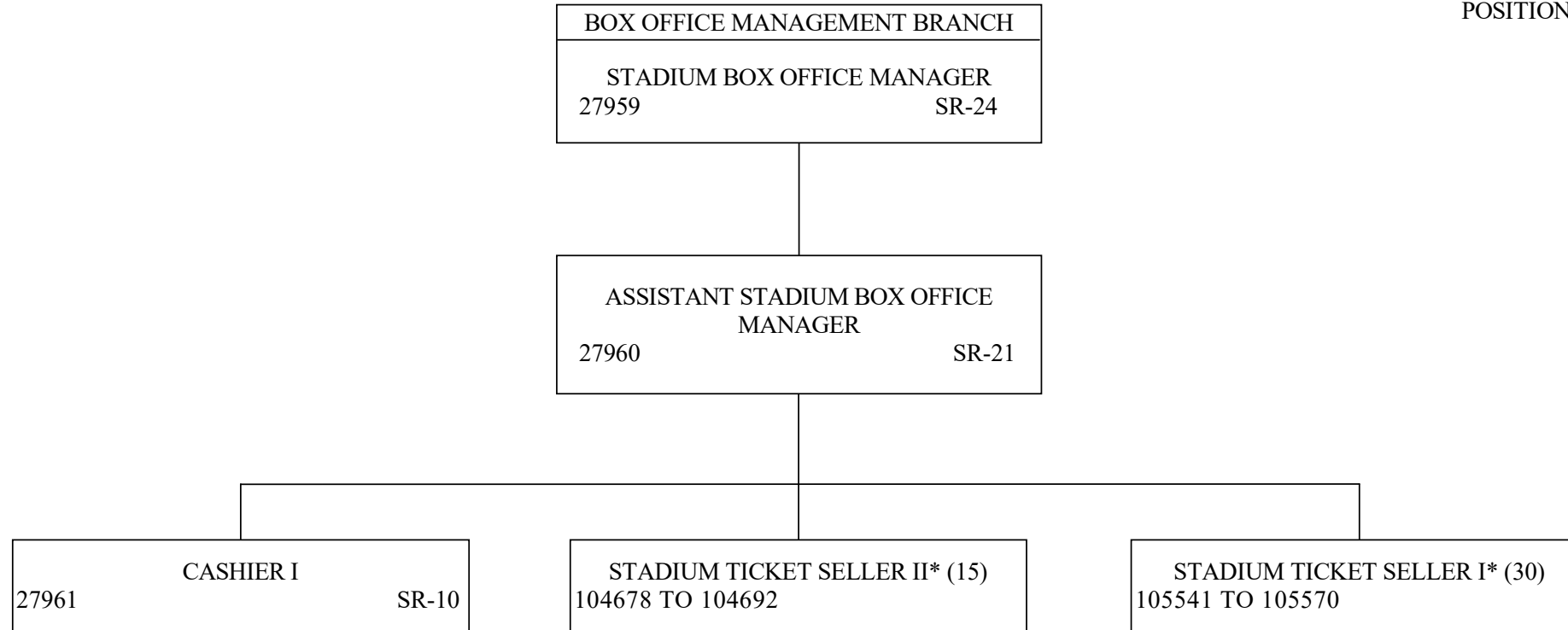

\*PART-TIME INTERMITTENT POSITIONS.

STATE OF HAWAII  
DEPARTMENT OF ACCOUNTING AND GENERAL SERVICES  
STADIUM AUTHORITY  
SECURITY MANAGEMENT BRANCH

POSITION ORGANIZATION CHART

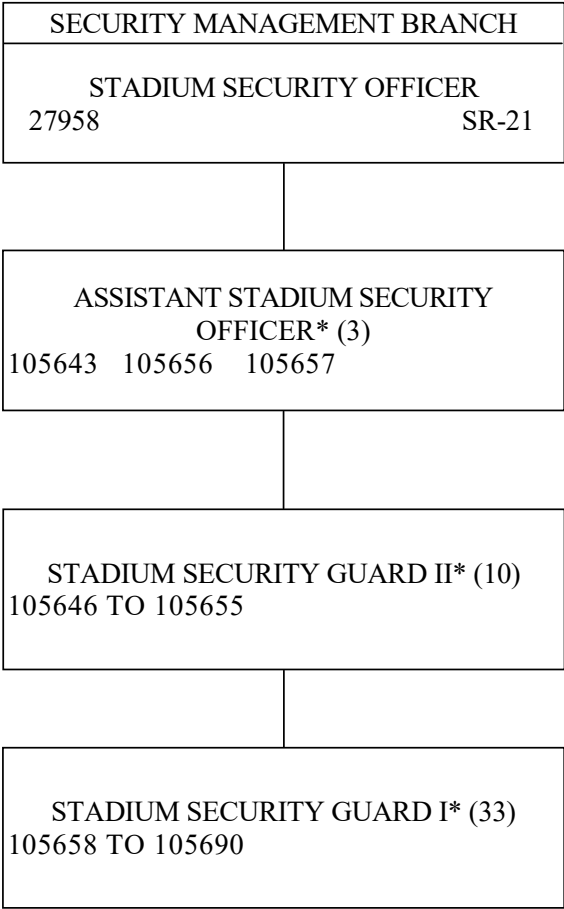

\*PART-TIME INTERMITTENT POSITIONS.



STATE OF HAWAII  
DEPARTMENT OF ACCOUNTING AND GENERAL SERVICES  
PROCUREMENT POLICY BOARD

ORGANIZATION CHART

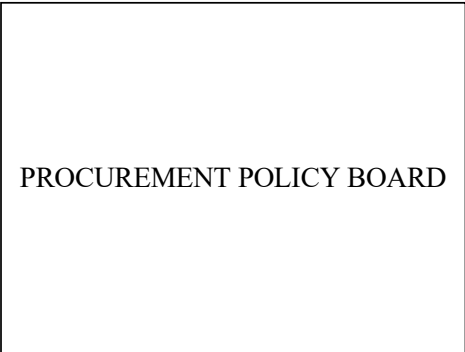

PURSUANT TO SECTION 103D-201, HRS, THE PROCUREMENT POLICY BOARD SHALL BE ASSISTED BY THE DEPARTMENT OF ACCOUNTING AND GENERAL SERVICES, WHICH SHALL PROVIDE AT LEAST ONE FULL-TIME SUPPORT STAFF AND FUNDING NECESSARY TO SUPPORT THE PROCUREMENT POLICY BOARD.

STATE OF HAWAII  
DEPARTMENT OF ACCOUNTING AND GENERAL SERVICES  
STATE PROCUREMENT OFFICE

ORGANIZATION CHART

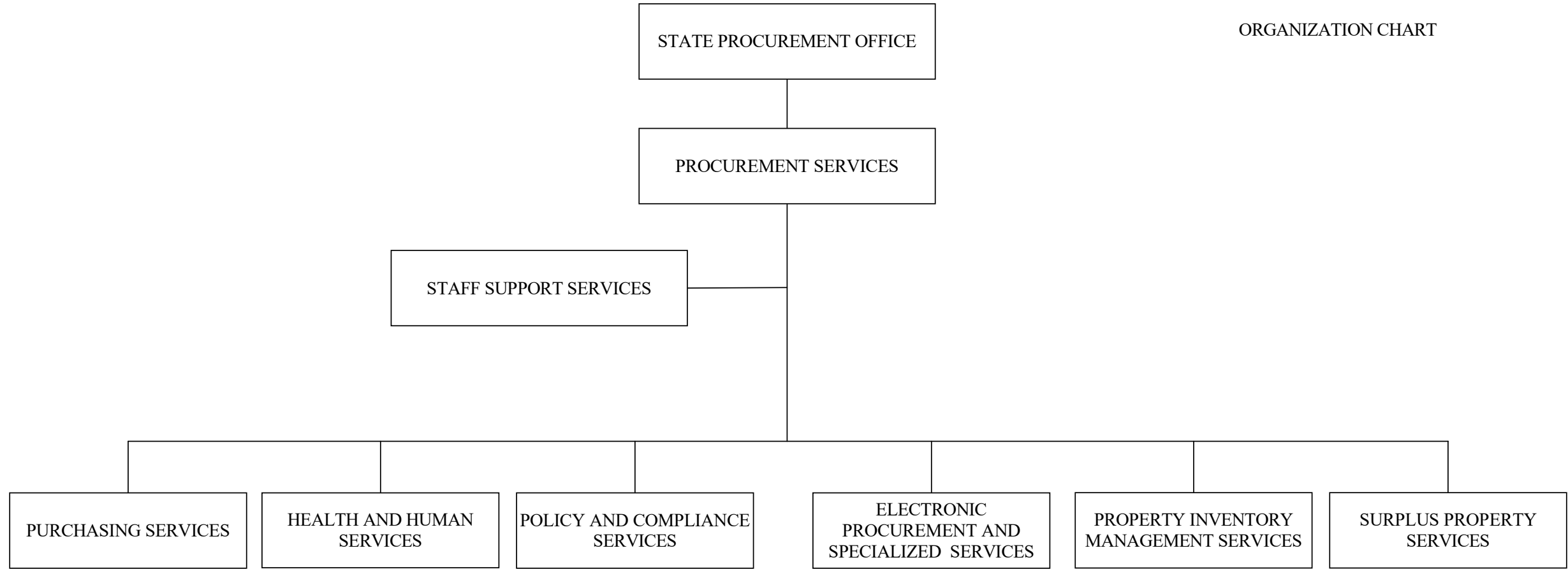
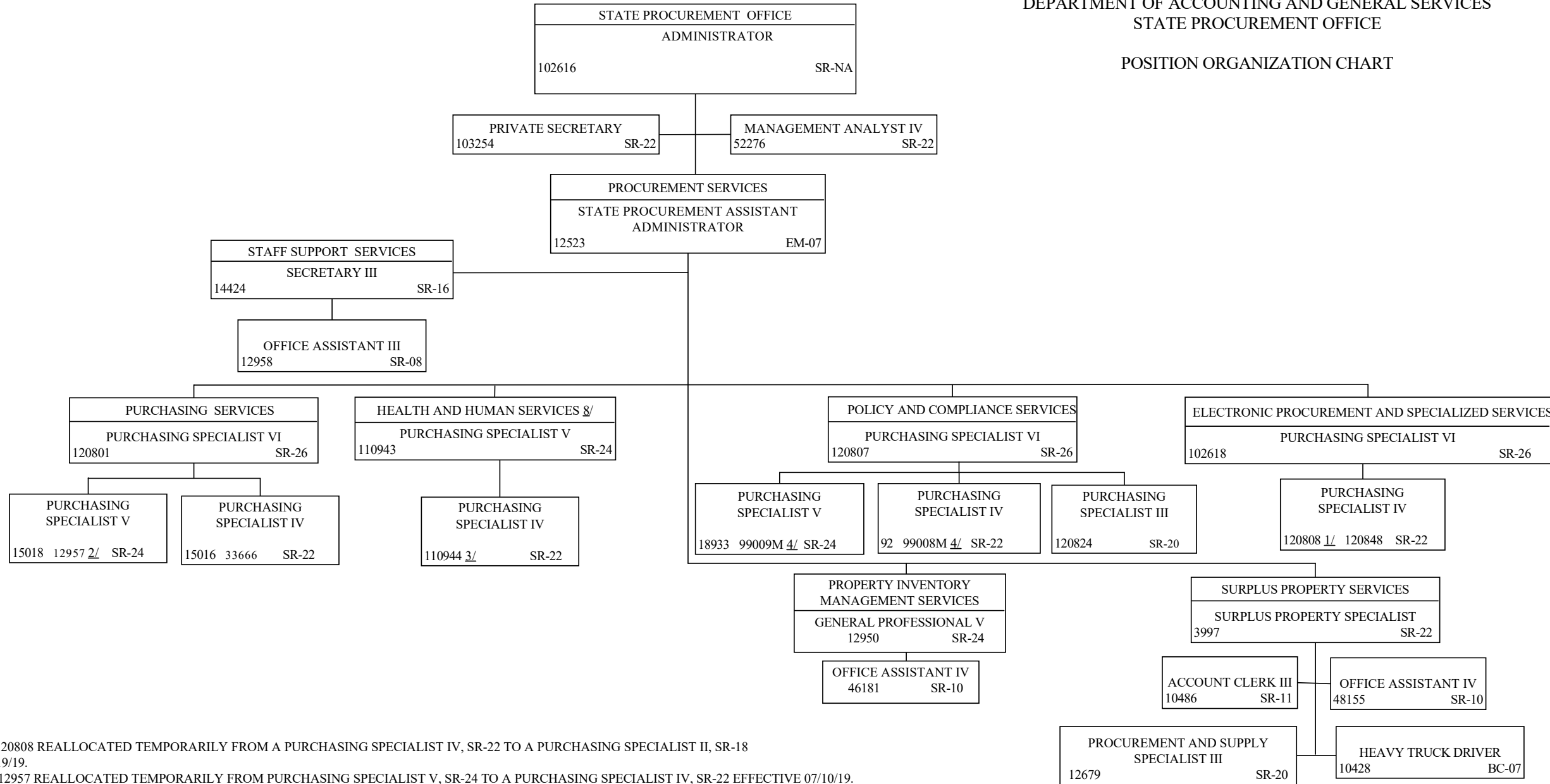

CHART XVIII

STATE OF HAWAII  
DEPARTMENT OF ACCOUNTING AND GENERAL SERVICES  
STATE PROCUREMENT OFFICE

POSITION ORGANIZATION CHART



1/ POSITION NO. 120808 REALLOCATED TEMPORARILY FROM A PURCHASING SPECIALIST IV, SR-22 TO A PURCHASING SPECIALIST II, SR-18 EFFECTIVE 03/19/19.

2/ POSITION NO. 12957 REALLOCATED TEMPORARILY FROM PURCHASING SPECIALIST V, SR-24 TO A PURCHASING SPECIALIST IV, SR-22 EFFECTIVE 07/10/19.

3/ POSITION NO. 110944 REALLOCATED TEMPORARILY TO PURCHASING SPECIALIST III, SR-20, EFFECTIVE 03/19/19.

4/ PURSUANT TO ACT 53, SLH 2018, CONSTRUCTION PROCUREMENT POSITIONS 99008M, PURCHASING SPECIALIST IV, SR-22, AND 99009M, PURCHASING SPECIALIST V, SR-24, TO BE ESTABLISHED.

STATE OF HAWAII  
DEPARTMENT OF ACCOUNTING AND GENERAL SERVICES  
OFFICE OF ELECTIONS

ORGANIZATION CHART

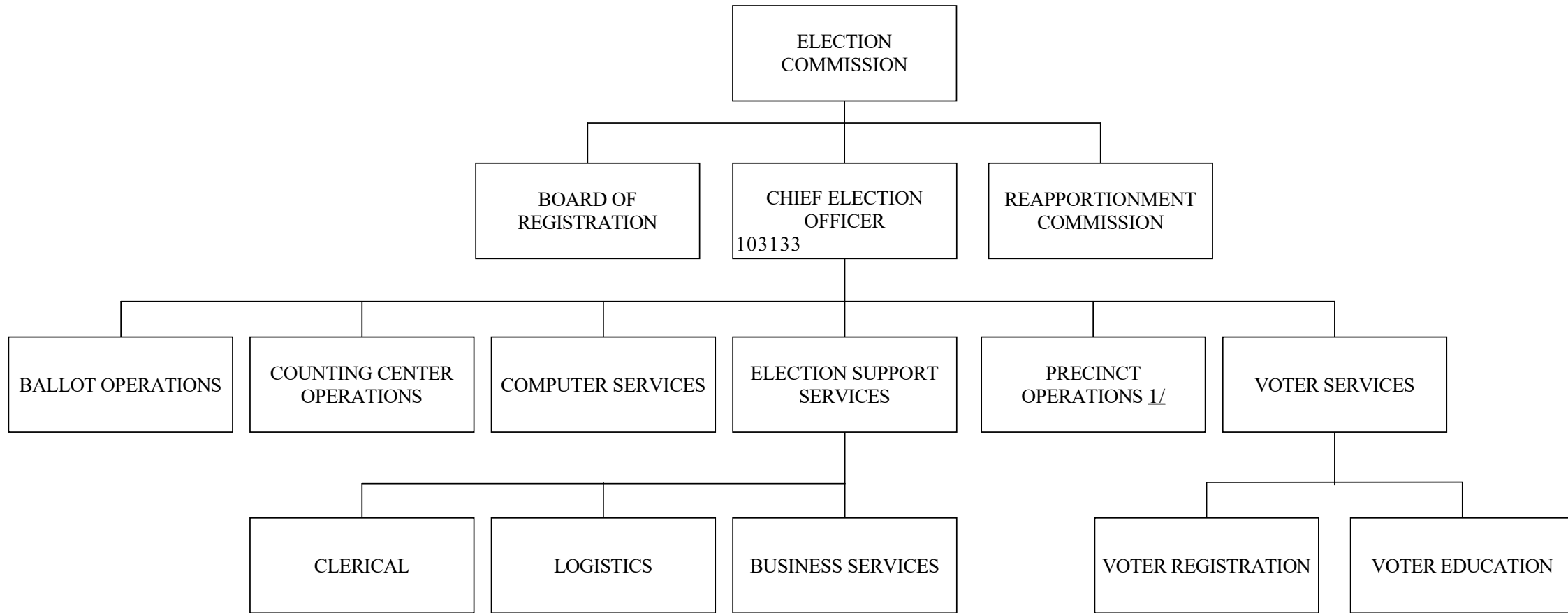

1/ PURSUANT TO ACT 136, SLH 2019, ELECTIONS IMPLEMENTED TO VOTE BY MAIL AND AS A RESULT THE PRECINCT OPERATIONS WILL BE REORGANIZED.

STATE OF HAWAII  
 DEPARTMENT OF ACCOUNTING AND GENERAL SERVICES  
 OFFICE OF ELECTIONS

POSITION ORGANIZATION CHART

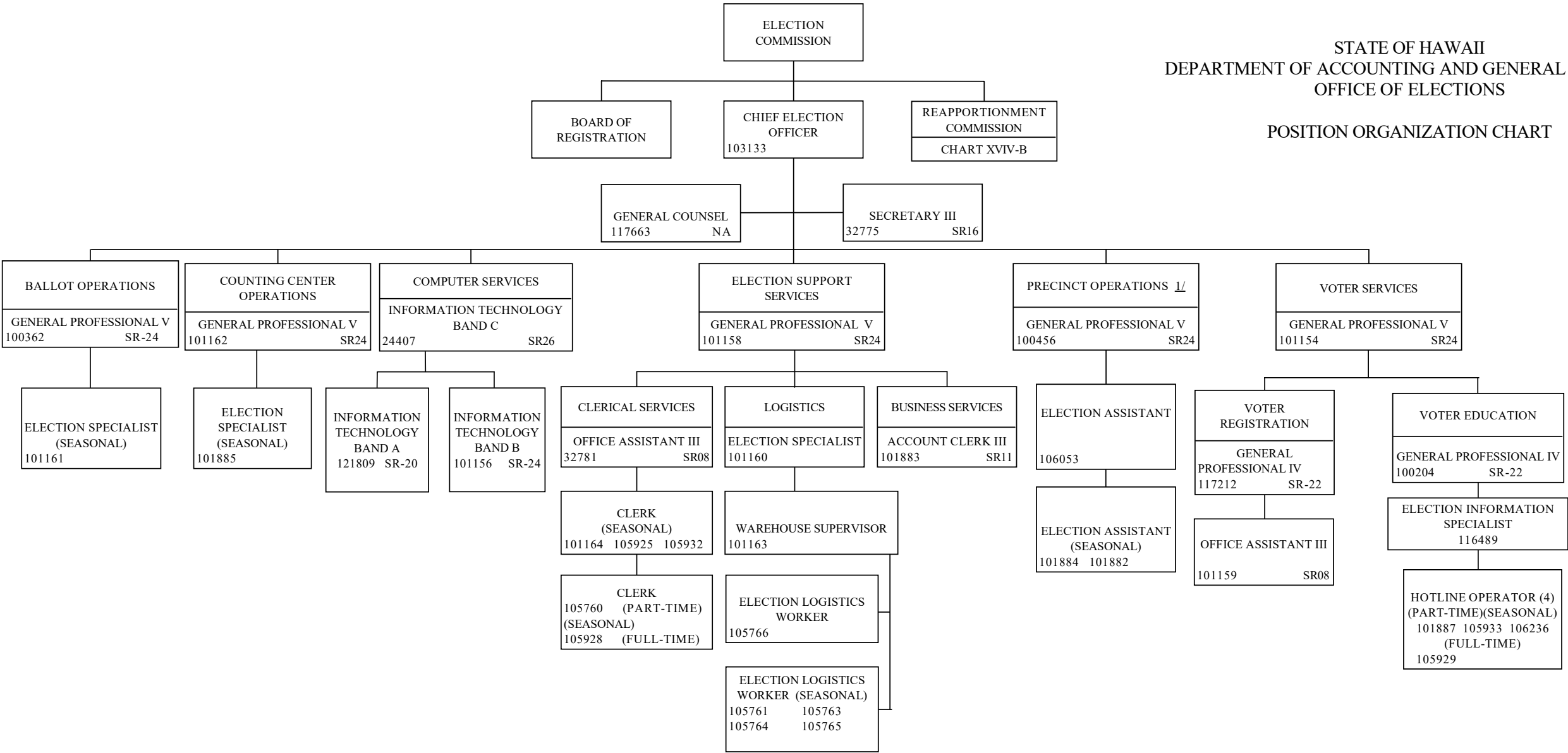

1/ PURSUANT TO ACT 136, SLH 2019, ELECTIONS IMPLEMENTED TO VOTE BY MAIL AND AS A RESULT THE PRECINCT OPERATIONS WILL BE REORGANIZED.

STATE OF HAWAII  
DEPARTMENT OF ACCOUNTING AND GENERAL SERVICES  
OFFICE OF ELECTIONS  
REAPPORTIONMENT COMMISSION  
POSITION ORGANIZATION CHART

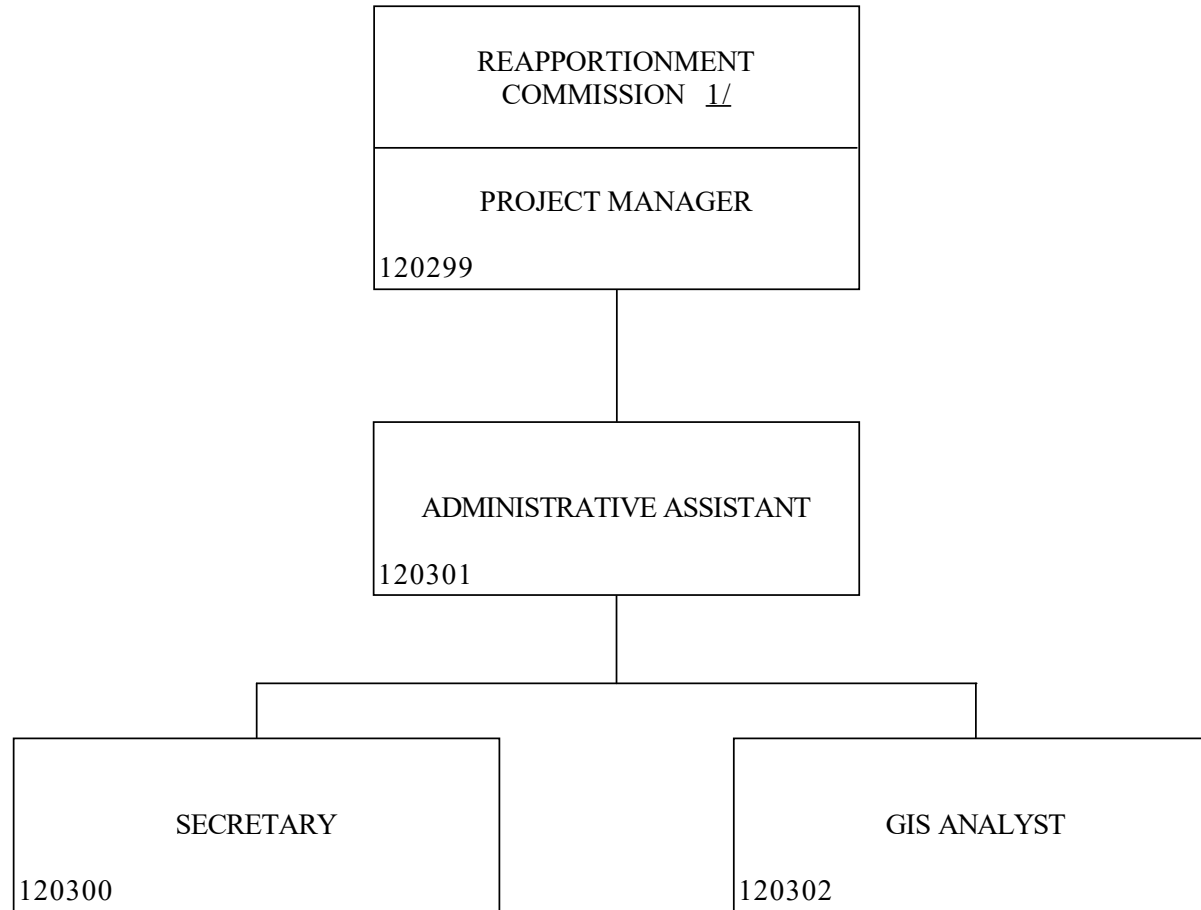

1/ POSITIONS ARE FUNDED FOR THE REAPPORTIONMENT COMMISSION CONSTITUTED EVERY TEN YEARS UNLESS REQUIRED BY COURT ORDER.  
FUNDING FOR THESE TEMPORARY POSITIONS IS REQUESTED IN THE BIENNIUM BUDGET PERIOD PRECEDING THE REAPPORTIONMENT YEAR.

STATE OF HAWAII  
DEPARTMENT OF ACCOUNTING AND GENERAL SERVICES  
CAMPAIGN SPENDING COMMISSION

ORGANIZATION CHART



STATE OF HAWAII  
DEPARTMENT OF ACCOUNTING AND GENERAL SERVICES  
CAMPAIGN SPENDING COMMISSION

POSITION ORGANIZATION CHART

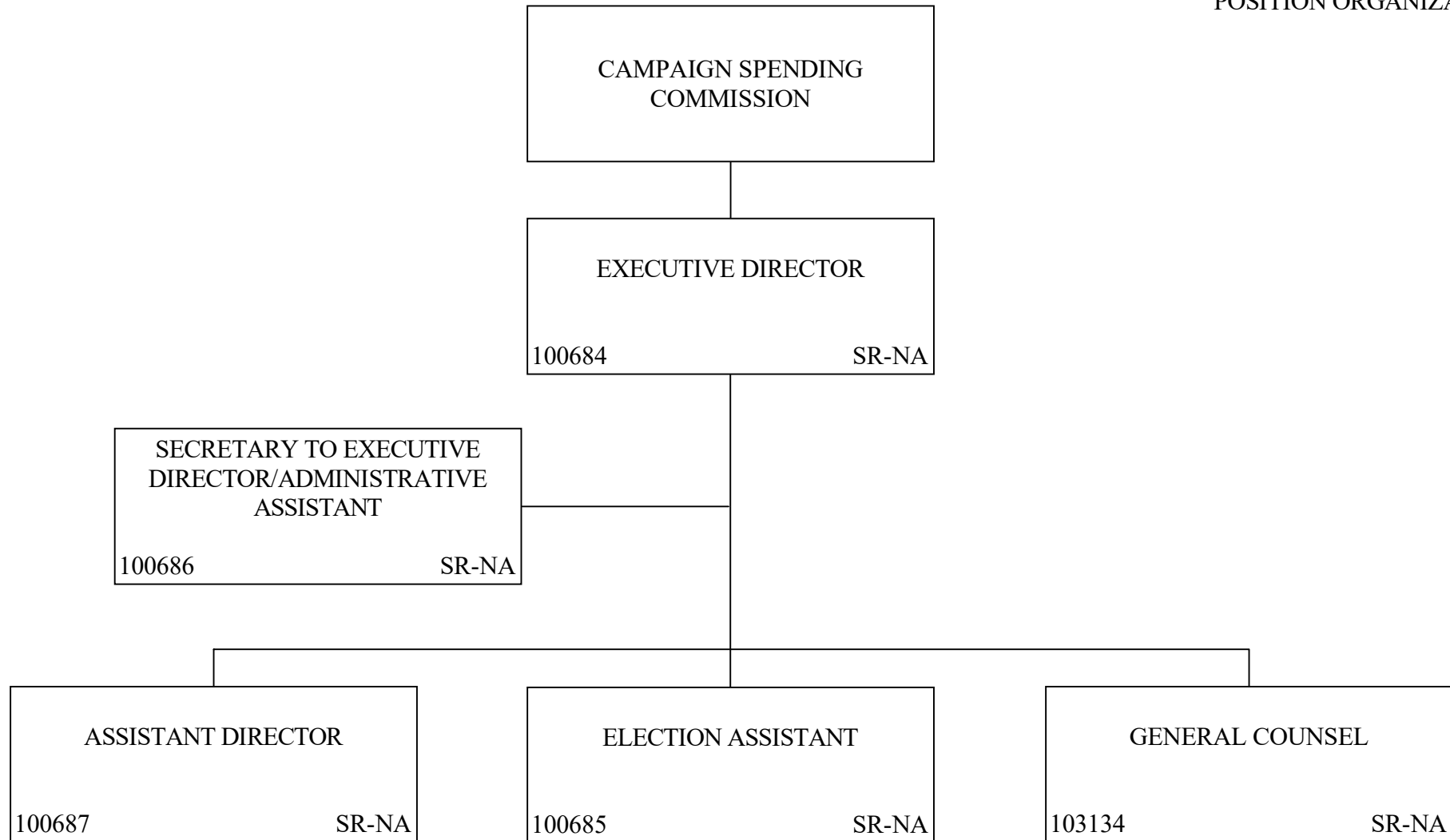



STATE OF HAWAII  
DEPARTMENT OF ACCOUNTING AND GENERAL SERVICES  
ENHANCED 911 BOARD

ORGANIZATION CHART

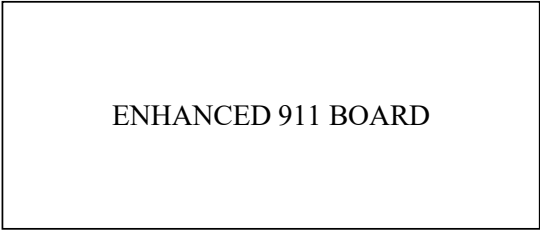

STATE OF HAWAII  
DEPARTMENT OF ACCOUNTING AND GENERAL SERVICES  
ENHANCED 911 BOARD

POSITION ORGANIZATION CHART

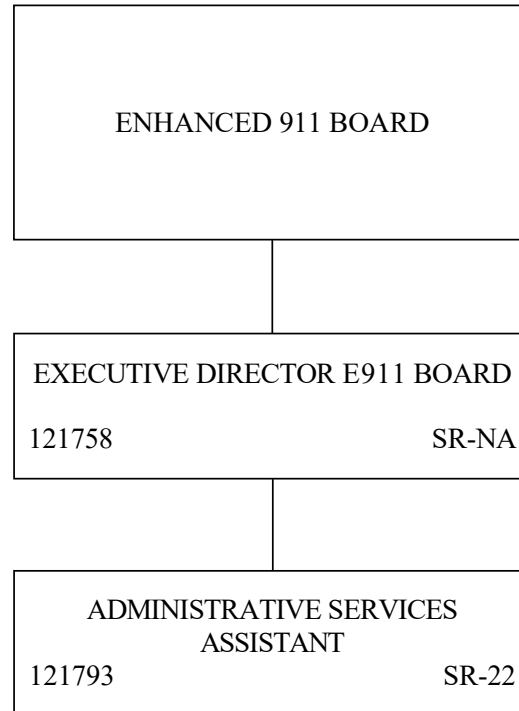

STATE OF HAWAII  
DEPARTMENT OF ACCOUNTING AND GENERAL SERVICES  
STATE BUILDING CODE COUNCIL

ORGANIZATION CHART



THERE ARE NO POSITIONS IN THIS PROGRAM.

STATE OF HAWAII  
DEPARTMENT OF ACCOUNTING AND GENERAL SERVICES  
INFORMATION PRIVACY AND SECURITY COUNCIL

ORGANIZATION CHART



THERE ARE NO POSITIONS IN THIS PROGRAM.

STATE OF HAWAII  
DEPARTMENT OF ACCOUNTING AND GENERAL SERVICES  
ACCESS HAWAII COMMITTEE

ORGANIZATION CHART

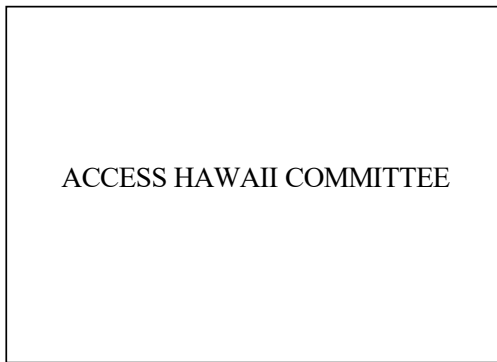

THERE ARE NO POSITIONS IN THIS PROGRAM.

STATE OF HAWAII  
DEPARTMENT OF ACCOUNTING AND GENERAL SERVICES  
OFFICE OF INFORMATION PRACTICES

ORGANIZATION CHART

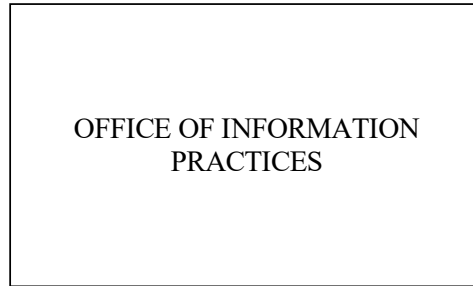

STATE OF HAWAII  
 DEPARTMENT OF ACCOUNTING AND GENERAL SERVICES  
 OFFICE OF INFORMATION PRACTICES

POSITION ORGANIZATION CHART

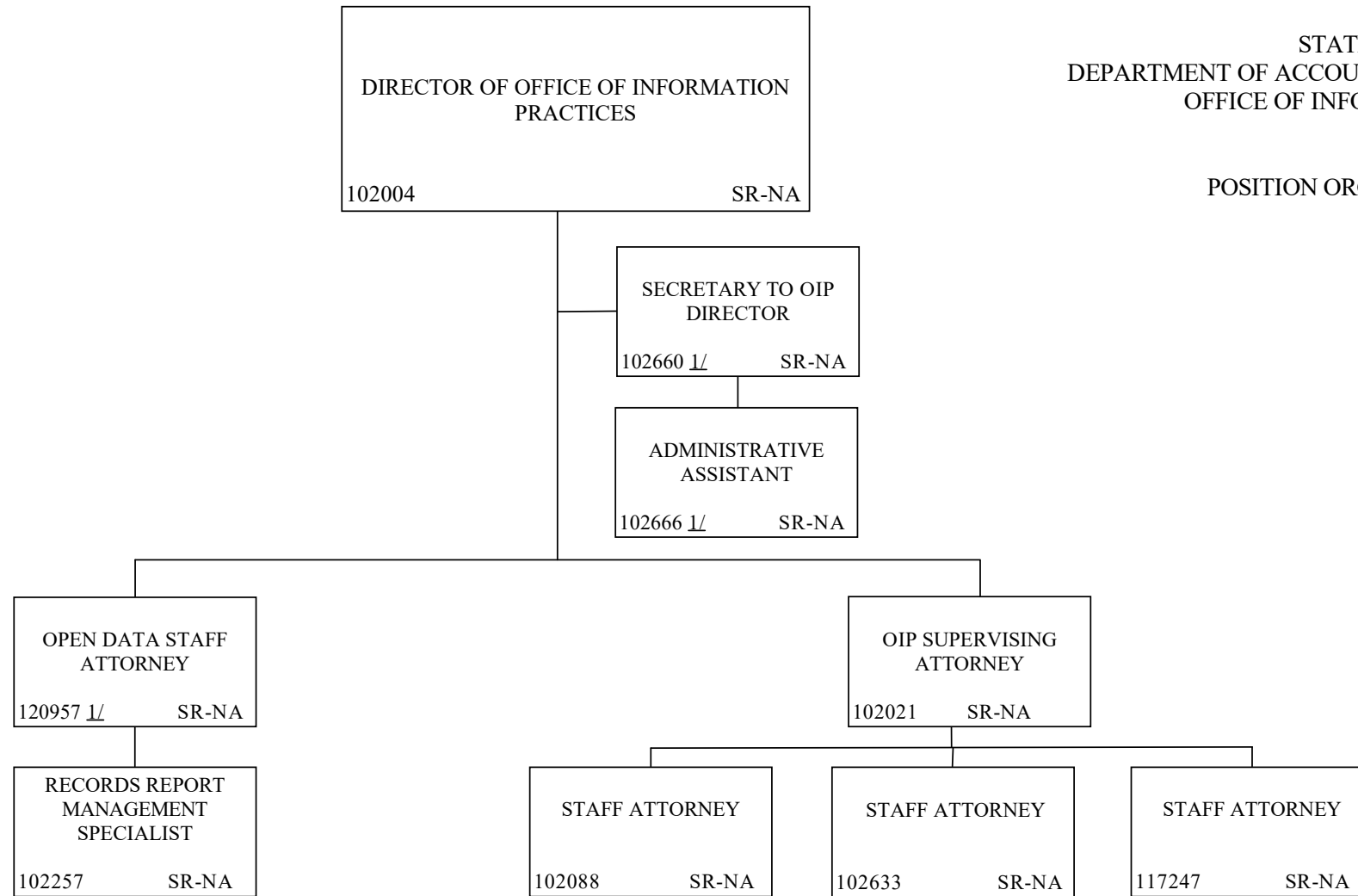

1/ NOTE: POSITION NO. 102666, ADMINISTRATIVE ASSISTANT IS CO-SUPERVISED BY BOTH POSITION NO. 102660, SECRETARY TO OIP DIRECTOR AND POSITION NO. 120957, OPEN DATA STAFF ATTORNEY.